

Schutzstromwandler

Rohrstab - Aufsteck - Vollverguss

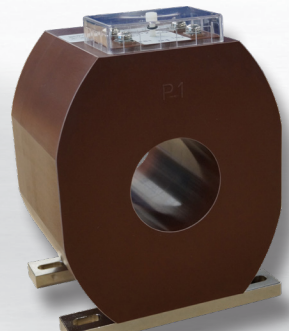

www.mbs-ag.com

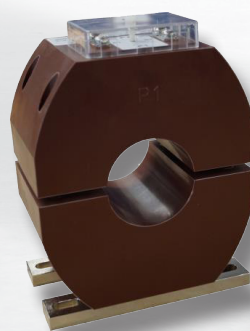
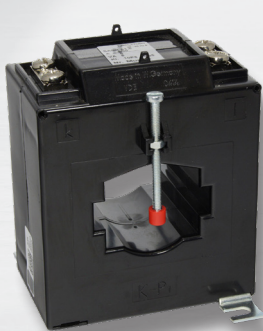



**Für Sie
gestalten wir die Zukunft
schon HEUTE !**



Schutzstromwandler

SEITE

Allgemein

Schutz-Stromwandler Technische Begriffe

4

Schutz-Rohrstab-Stromwandler

	Primärleiter	Rundleiter	Wandlerbreite
SASR 22.3		Ø 22,5 mm	61 mm

5

Schutz-Aufsteck-Stromwandler

	Primärleiter	Rundleiter	Wandlerbreite
SASK 21.3	20x10 mm	Ø 19,2 mm	61 mm
SASK 31.5	30x10 mm / 2x20x10 mm	Ø 28 mm	61 mm
SASK 31.6	30x10 mm / 20x13 mm	Ø 23 mm	95 mm
SASK 421.4	20x10 mm	Ø 20 mm	71 mm
SASK 41.4	40x10 mm / 2x30x5 mm	Ø 32 mm	71 mm
SASK 41.6	40x12 mm / 30x5 mm	Ø 32 mm	95 mm
SASK 41.10	40x10 mm	Ø 32 mm	150 mm
SASK 541.4	40x10 mm / 20x30x15 mm	Ø 32 mm	86 mm
SASK 51.4	50x12 mm / 2x40x10 mm	Ø 44 mm	86 mm
SASK 51.6	50x12 mm / 40x30 mm	Ø 40 mm	95 mm
SASK 61.4	60x10 mm / 2x50x10 mm	Ø 44 mm	96 mm
SASK 61.10	60x10 mm / 50x30 mm		150 mm
SASK 63.6	60x30 mm	Ø 30 mm	88 mm

6

7

8

12

13

14

16

20

22

23

25

26

30

Stromwandler im Vollverguss

Kabelumbau-Stromwandler CTR

32

Einteiliger Stromwandler CTO

33

Schutz-Stromwandler – Technische Begriffe

Anwendung: Stromwandler dienen der galvanisch getrennten, proportionalen Umwandlung von Wechselströmen großer Stromstärken in kleinere, direkt messbare Werte. Entsprechend ihrer Verwendung erfolgt eine Unterscheidung in zwei Typen:

- Messwandler
- Schutzwandler

Alle Stromwandler sind für den Einsatz in Niederspannungsnetzen mit einer maximalen Leiter-Leiter-Spannung von 0,72 kV konzipiert.

Messwandler: Messwandler werden zur Messung von Strom, Leistung, Leistungsfaktor und Energieverbrauch unter direkter Verwendung eines entsprechenden Messgerätes verwendet. Durch die Dimensionierung ihres magnetischen Kreises ermöglichen Messwandler eine hohe Übertragungsgenauigkeit im Nennstrombereich, bei gleichzeitigem Schutz der angeschlossenen Geräte im Überstromfall. Dieser Schutz wird durch die im Überstromfall eintretende magnetische Sättigung des Messkernes verursacht.

Schutzwandler: Schutzstromwandler dienen der Ansteuerung von Schutzrelais, welche die Aufgabe haben, nachgeschaltete Schaltungen im Überstromfall zu trennen. Für eine sichere Funktion dieser Relais ist ein proportionales Übertragungsverhalten des Wandlers bis zu einem Vielfachen des Nennstromes erforderlich. Die Dimensionierung dieser Wandlerbauform stellt eine proportionale Stromübertragung bis zu einem von der Schutzklasse bestimmten Vielfachen des Nennstroms sicher.

Technische Normen: Alle Stromwandler werden in Übereinstimmung mit den technischen Forderungen der IEC 61869/1+2 (vormals IEC 60044-1) gefertigt.

Technische Merkmale: Einsatzort: Innenräume, ohne Betauung.

Schutz-Stromwandler:

- Umgebungstemperaturbereich: $-5^{\circ}\text{C} \dots +40^{\circ}\text{C}$.
- Gehäusematerial: Polykarbonat, selbstverlöschend
- Gehäusebauform: Halbschalengehäuse, ultraschallverschweißt
- Isolierstoffklasse: E
- Thermische Bemessungs-Dauerstromstärke: $1.2 \times I_{pr}$
- Sekundäre Bemessungs-Stromstärken: 5 A bzw. 1 A
- Thermische Bemessungs-Kurzzeitstromstärke: $60 \times I_{pr}$ (max. 100 kA)
- Max. Übertemperatur der Sekundärwicklung: 75 K
- Isolationsprüfspannung: 3 kV U_{eff} ; 50 Hz, 1 min

Sicherheitshinweis: Bedingt durch das physikalische Wirkprinzip können beim Betrieb des Stromwandlers mit offenem Sekundärkreis an dessen Anschlussklemmen für den Menschen gefährliche Spannungen auftreten. Besonders bei Schutz-Stromwandlern können dabei Spannungen von mehreren Kilovolt auftreten. Zur Vermeidung von Personen- bzw. Wandler Schäden ist ein solcher Betriebszustand untersagt!

Bestellhinweis: Zur korrekten Bearbeitung Ihrer Bestellung bitten wir um vollständige Übermittlung folgender Angaben:

Wandlertyp
 Übersetzungsverhältnis
 Genauigkeitsklasse
 Bemessungsbürde

Grenzwerte der Messabweichung für Stromwandler für Schutzzwecke der Klassen P			
Genauigkeitsklasse	Übersetzungsmessabweichung bei primärem Bemessungsstrom $\pm \%$	Fehlwinkel bei primärem Bemessungsstrom \pm Minuten	Gesamtmessabweichung bei Bemessungs-Genauigkeitsgrenzstrom %
5P	1	60	5
10P	3	–	10

SASR 22.3

Schutz-Rohrstab-Stromwandler



Rundleiter 22,5 mm
 Baubreite 61 mm
 Bauhöhe 75,5 mm
 Bautiefe gesamt 35 mm

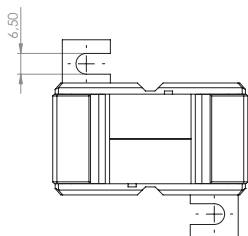
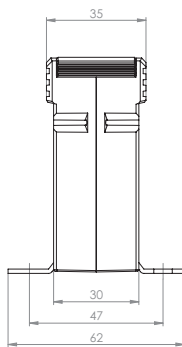
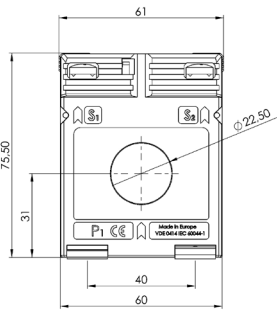

Primärstrom [A]	Bürde [VA]	Sekundärstrom [A] / Klasse			
		5 A Kl. 5P5 Best.-Nr.	5 A Kl. 10P5 Best.-Nr.	1 A Kl. 5P5 Best.-Nr.	1 A Kl. 10P5 Best.-Nr.
100	1			S04-1316B	S04-1317B
125	1	S04-1506B	S04-1507B		
	1,5			S04-1516C	S04-1517C
150	1	S04-1606B	S04-1607B		
	1,5			S04-1616C	S04-1617C
200	1	S04-1706B	S04-1707B		
	1,5			S04-1716C	S04-1717C
250	1	S04-1806B	S04-1807B		
	1,5			S04-1816C	S04-1817C
300	1	S04-1906B	S04-1907B		
	1,5		S04-1907C	S04-1916C	S04-1917C

		Best.-Nr.
	Schnappbefestigung Form A	53011
	Plombierplatte Form A	59040

SASK 21.3



Schutz-Aufsteck-Stromwandler

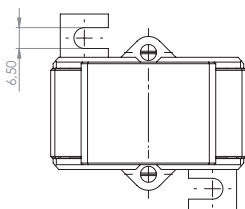
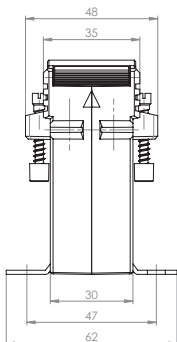
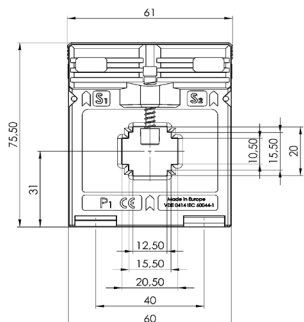

Schiene 1 20 x 10 mm
 Rundleiter 19,2 mm
 Baubreite 61 mm
 Bauhöhe 75,5 mm
 Bautiefe gesamt 48 mm



Primärstrom [A]	Bürde [VA]	Sekundärstrom [A] / Klasse			
		5 A Kl. 5P5 Best.-Nr.	5 A Kl. 10P5 Best.-Nr.	1 A Kl. 5P5 Best.-Nr.	1 A Kl. 10P5 Best.-Nr.
125	1	S03-1506B	S03-1507B		
	1,5			S03-1516C	S03-1517C
150	1	S03-1606B	S03-1607B		
	1,5			S03-1616C	S03-1617C
200	1	S03-1706B	S03-1707B		
	1,5			S03-1716C	S03-1717C

		Best.-Nr.
	Schnappbefestigung Form A	53011
	Plombierplatte Form A	59040

SASK 31.5

Schutz-Aufsteck-Stromwandler



Schiene 1 30 x 10 mm
 Schiene 2 2 x 20 x 10 mm
 Rundleiter 28 mm
 Baubreite 61 mm
 Bauhöhe 75,5 mm
 Bautiefe gesamt 68 mm

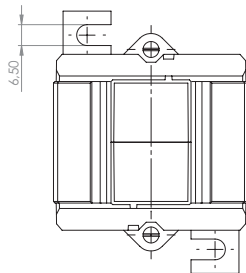
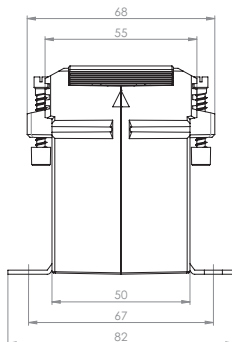
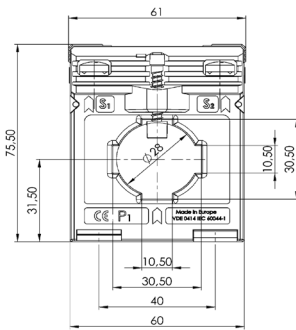

Primärstrom [A]	Bürde [VA]	Sekundärstrom [A] / Klasse			
		5 A Kl. 5P5 Best.-Nr.	5 A Kl. 10P5 Best.-Nr.	1 A Kl. 5P5 Best.-Nr.	1 A Kl. 10P5 Best.-Nr.
75	1			S17-1116B	S17-1117B
80	1			S17-1216B	S17-1217B
100	1	S17-1306B	S17-1307B		
	1,5			S17-1316C	S17-1317C
125	1	S17-1506B	S17-1507B		
	1,5		S17-1507C	S17-1516C	S17-1517C
150	1	S17-1606B	S17-1607B		
	1,5	S17-1606C	S17-1607C	S17-1616C	S17-1617C
200	1	S17-1706B	S17-1707B		
	1,5	S17-1706C	S17-1707C	S17-1716C	S17-1717C
	2,5	S17-1706D	S17-1707D	S17-1716D	S17-1717D
250	1,5	S17-1806C	S17-1807C	S17-1816C	S17-1817C
	2,5	S17-1806D	S17-1807D	S17-1816D	S17-1817D
300	1,5	S17-1906C	S17-1907C	S17-1916C	S17-1917C
	2,5	S17-1906D	S17-1907D	S17-1916D	S17-1917D
400	1,5	S17-2006C	S17-2007C	S17-2016C	S17-2017C
	2,5	S17-2006D	S17-2007D	S17-2016D	S17-2017D
500	1,5	S17-2106C	S17-2107C	S17-2116C	S17-2117C
	2,5	S17-2106D	S17-2107D	S17-2116D	S17-2117D
600	1,5	S17-2206C	S17-2207C	S17-2216C	S17-2217C
	2,5	S17-2206D	S17-2207D	S17-2216D	S17-2217D
750	1,5	S17-2306C	S17-2307C	S17-2316C	S17-2317C
	2,5	S17-2306D	S17-2307D	S17-2316D	S17-2317D

		Best.-Nr.
	Schnappbefestigung Form C	55011
	Plombierplatte Form B	59041

SASK 31.6

Schutz-Aufsteck-Stromwandler



- Schiene 1 30 x 10 mm
- Schiene 2 20 x 13 mm
- Rundleiter 23 mm
- Baubreite 95 mm
- Bauhöhe 116 mm
- Bautiefe gesamt 74 mm

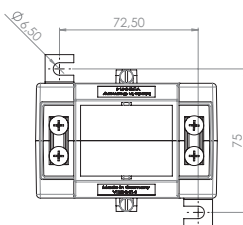
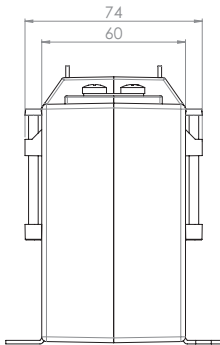
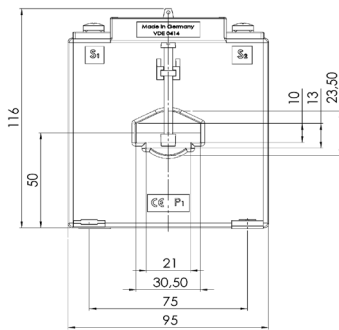

Primärstrom [A]	Bürde [VA]	Sekundärstrom [A] / Klasse		
		5 A Kl. 5P5 Best.-Nr.	5 A Kl. 10P5 Best.-Nr.	5 A Kl. 5P10 Best.-Nr.
50	1,5	S19-0906C	S19-0907C	
	2,5	S19-0906D	S19-0907D	
60	1,5	S19-1006C	S19-1007C	
	2,5	S19-1006D	S19-1007D	
80	1,5			S19-1208C
	2,5	S19-1206D	S19-1207D	
	5	S19-1206F	S19-1207F	
100	1,5	S19-1306C	S19-1307C	S19-1308C
	2,5	S19-1306D	S19-1307D	S19-1308D
	5	S19-1306F	S19-1307F	
150	2,5	S19-1606D	S19-1607D	S19-1608D
	5	S19-1606F	S19-1607F	S19-1608F
	7,5	S19-1606G	S19-1607G	
200	2,5	S19-1706D	S19-1707D	S19-1708D
	5	S19-1706F	S19-1707F	S19-1708F
	7,5	S19-1706G	S19-1707G	
	10	S19-1706H	S19-1707H	
250	2,5	S19-1806D	S19-1807D	S19-1808D
	5	S19-1806F	S19-1807F	S19-1808F
	7,5	S19-1806G	S19-1807G	
	10	S19-1806H	S19-1807H	
300	2,5	S19-1906D	S19-1907D	S19-1908D
	5	S19-1906F	S19-1907F	S19-1908F
	10	S19-1906H	S19-1907H	
400	2,5	S19-2006D	S19-2007D	S19-2008D
	5	S19-2006F	S19-2007F	S19-2008F
	7,5	S19-2006G	S19-2007G	S19-2008G
	10	S19-2006H	S19-2007H	S19-2008H
	15	S19-2006J	S19-2007J	
500	2,5	S19-2106D	S19-2107D	S19-2108D
	5	S19-2106F	S19-2107F	S19-2108F
	7,5	S19-2106G	S19-2107G	S19-2108G
	10	S19-2106H	S19-2107H	S19-2108H
	15	S19-2106J	S19-2107J	
600	2,5	S19-2206D	S19-2207D	S19-2208D
	5	S19-2206F	S19-2207F	S19-2208F
	7,5	S19-2206G	S19-2207G	S19-2208G
	10	S19-2206H	S19-2207H	S19-2208H
	15	S19-2206J	S19-2207J	
750	2,5	S19-2306D	S19-2307D	S19-2308D
	5	S19-2306F	S19-2307F	S19-2308F
	7,5	S19-2306G	S19-2307G	S19-2308G
	10	S19-2306H	S19-2307H	S19-2308H
	15	S19-2306J	S19-2307J	

SASK 31.6



Schutz-Aufsteck-Stromwandler

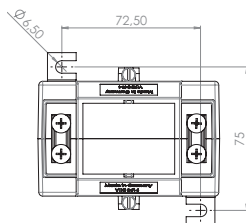
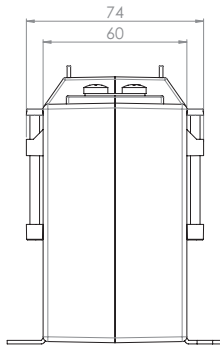
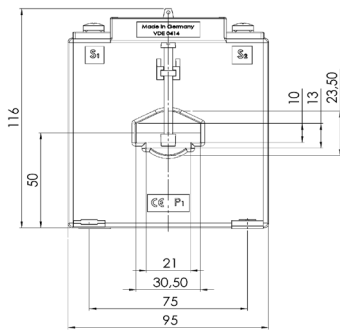

Schiene 1 30 x 10 mm
 Schiene 2 20 x 13 mm
 Rundleiter 23 mm
 Baubreite 95 mm
 Bauhöhe 116 mm
 Bautiefe gesamt 74 mm



Primärstrom [A]	Bürde [VA]	Sekundärstrom [A] / Klasse		
		5 A Kl. 10P10 Best.-Nr.	5 A Kl. 5P15 Best.-Nr.	5 A Kl. 10P15 Best.-Nr.
60	1,5	S19-1009C		
80	1,5	1S19-1209C		
100	1,5	S19-1309C	100S19-130AC	100S19-130BC
	2,5	S19-1309D		
150	2,5	S19-1609D	S19-160AD	S19-160BD
	5	S19-1609F		
200	2,5	S19-1709D	S19-170AD	S19-170BD
	5	S19-1709F		
250	2,5	S19-1809D	S19-180AD	S19-180BD
	5	S19-1809F		
300	2,5	S19-1909D	S19-190AD	S19-190BD
	5	S19-1909F		
400	2,5	S19-2009D	S19-200AD	S19-200BD
	5	S19-2009F	S19-200AF	S19-200BF
	7,5	S19-2009G		
	10	S19-2009H		
500	2,5	S19-2109D	S19-210AD	S19-210BD
	5	S19-2109F	S19-210AF	S19-210BF
	7,5	S19-2109G		
	10	S19-2109H		
600	2,5	S19-2209D	S19-220AD	S19-220BD
	5	S19-2209F	S19-220AF	S19-220BF
	7,5	S19-2209G		
	10	S19-2209H		
750	2,5	S19-2309D	S19-230AD	S19-230BD
	5	S19-2309F	S19-230AF	S19-230BF
	7,5	S19-2309G		
	10	S19-2309H		

		Best.-Nr.
	Schnappbefestigung	–
	Plombierplatte Form E	59044

SASK 31.6

Schutz-Aufsteck-Stromwandler



Schiene 1 30 x 10 mm
 Schiene 2 20 x 13 mm
 Rundleiter 23 mm
 Baubreite 95 mm
 Bauhöhe 116 mm
 Bautiefe gesamt 74 mm

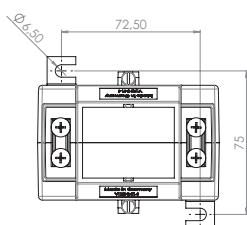
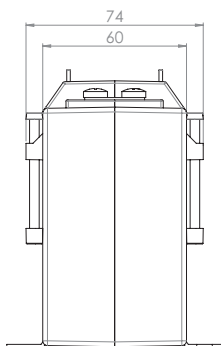
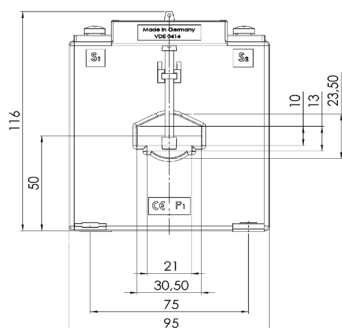

Primärstrom [A]	Bürde [VA]	Sekundärstrom [A] / Klasse		
		1 A Kl. 5P5 Best.-Nr.	1 A Kl. 10P5 Best.-Nr.	1 A Kl. 5P10 Best.-Nr.
50	1,5	S19-0916C	S19-0917C	
	2,5	S19-0916D	S19-0917D	
60	1,5	S19-1016C	S19-1017C	S19-1018C
	2,5	S19-1016D	S19-1017D	
80	1,5	S19-1216C	S19-1217C	S19-1218C
	2,5	S19-1216D	S19-1217D	S19-1218D
	5		S19-1217F	
100	2,5	S19-1316D	S19-1317D	S19-1318D
	5	S19-1316F	S19-1317F	
150	2,5	S19-1616D	S19-1617D	S19-1618D
	5	S19-1616F	S19-1617F	S19-1618F
200	2,5	S19-1716D	S19-1717D	S19-1718D
	5	S19-1716F	S19-1717F	S19-1718F
	7,5	S19-1716G	S19-1717G	
	10	S19-1716H	S19-1717H	
250	2,5	S19-1816D	S19-1817D	S19-1818D
	5	S19-1816F	S19-1817F	S19-1818F
	7,5	S19-1816G	S19-1817G	
300	2,5	S19-1916D	S19-1917D	S19-1918D
	5	S19-1916F	S19-1917F	S19-1918F
	10	S19-1916H	S19-1917H	
400	2,5	S19-2016D	S19-2017D	S19-2018D
	5	S19-2016F	S19-2017F	S19-2018F
	7,5	S19-2016G	S19-2017G	S19-2018G
	10	S19-2016H	S19-2017H	S19-2018H
500	15	S19-2016J	S19-2017J	
	2,5	S19-2116D	S19-2117D	S19-2118D
	5	S19-2116F	S19-2117F	S19-2118F
	7,5	S19-2116G	S19-2117G	S19-2118G
600	10	S19-2116H	S19-2117H	S19-2118H
	15	S19-2116J	S19-2117J	
	2,5	S19-2216D	S19-2217D	S19-2218D
	5	S19-2216F	S19-2217F	S19-2218F
750	7,5	S19-2216G	S19-2217G	S19-2218G
	10	S19-2216H	S19-2217H	S19-2218H
	15	S19-2216J	S19-2217J	
	2,5	S19-2316D	S19-2317D	S19-2318D
750	5	S19-2316F	S19-2317F	S19-2318F
	7,5	S19-2316G	S19-2317G	S19-2318G
	10	S19-2316H	S19-2317H	S19-2318H
	15	S19-2316J	S19-2317J	

SASK 31.6



Schutz-Aufsteck-Stromwandler

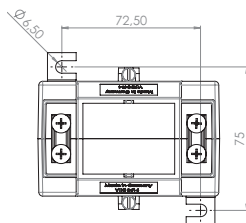
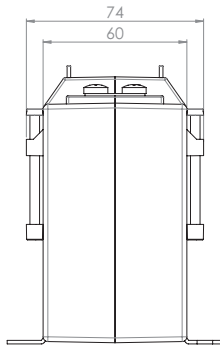
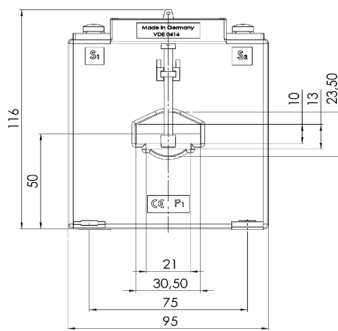

Schiene 1	30 x 10 mm
Schiene 2	20 x 13 mm
Rundleiter	23 mm
Baubreite	95 mm
Bauhöhe	116 mm
Bautiefe gesamt	74 mm



Primärstrom [A]	Bürde [VA]	Sekundärstrom [A] / Klasse		
		1 A Kl. 10P10 Best.-Nr.	1 A Kl. 5P15 Best.-Nr.	1 A Kl. 10P15 Best.-Nr.
60	1,5	S19-1019C		
80	1,5	S19-1219C		
	2,5	S19-1219D		
100	1,5		S19-131AC	S19-131BC
	2,5	S19-1319D		
150	2,5	S19-1619D	S19-161AD	S19-161BD
	5	S19-1619F		
200	2,5	S19-1719D	S19-171AD	S19-171BD
	5	S19-1719F		
250	2,5	S19-1819D	S19-181AD	S19-181BD
	5	S19-1819F		
300	2,5	S19-1919D	S19-191AD	S19-191BD
	5	S19-1919F		
400	2,5	S19-2019D	S19-201AD	S19-201BD
	5	S19-2019F	S19-201AF	S19-201BF
	7,5	S19-2019G		
	10	S19-2019H		
500	2,5	S19-2119D	S19-211AD	S19-211BD
	5	S19-2119F	S19-211AF	S19-211BF
	7,5	S19-2119G		
	10	S19-2119H		
600	2,5	S19-2219D	S19-221AD	S19-221BD
	5	S19-2219F	S19-221AF	S19-221BF
	7,5	S19-2219G		
	10	S19-2219H		
750	2,5	S19-2319D	S19-231AD	S19-231BD
	5	S19-2319F	S19-231AF	S19-231BF
	7,5	S19-2319G		
	10	S19-2319H		

		Best.-Nr.
	Schnappbefestigung	–
	Plombierplatte Form E	59044

SASK 421.4



Schutz-Aufsteck-Stromwandler

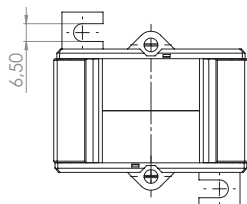
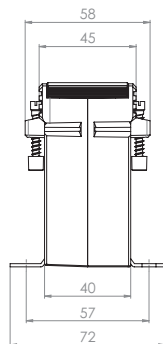
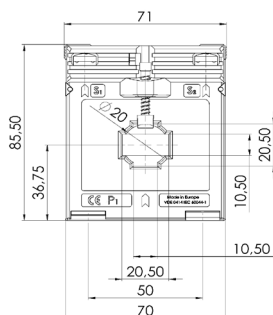

Schiene 1 20 x 10 mm
 Rundleiter 20 mm
 Baubreite 71 mm
 Bauhöhe 85,5 mm
 Bautiefe gesamt 58 mm



Primärstrom [A]	Bürde [VA]	Sekundärstrom [A] / Klasse			
		5 A Kl. 5P5 Best.-Nr.	5 A Kl. 10P5 Best.-Nr.	1 A Kl. 5P5 Best.-Nr.	1 A Kl. 10P5 Best.-Nr.
100	2,5	S23-1306D	S23-1307D	S23-1316D	S23-1317D
150	2,5	S23-1606D	S23-1607D	S23-1616D	S23-1617D
200	1,5	S23-1706C	S23-1707C	S23-1716C	S23-1717C
	2,5	S23-1706D	S23-1707D	S23-1716D	S23-1717D
250	1,5	S23-1806C	S23-1807C	S23-1816C	S23-1817C
	2,5	S23-1806D	S23-1807D	S23-1816D	S23-1817D
300	1,5	S23-1906C	S23-1907C	S23-1916C	S23-1917C
	2,5	S23-1906D	S23-1907D	S23-1916D	S23-1917D
400	1,5	S23-2006C	S23-2007C	S23-2016C	S23-2017C
	2,5	S23-2006D	S23-2007D	S23-2016D	S23-2017D

		Best.-Nr.
	Schnappbefestigung	—
	Plombierplatte Form B	59041

SASK 41.4

Schutz-Aufsteck-Stromwandler



Schiene 1 40 x 10 mm
 Schiene 2 2 x 30 x 5 mm
 Rundleiter 32 mm
 Baubreite 71 mm
 Bauhöhe 85,5 mm
 Bautiefe gesamt 58 mm

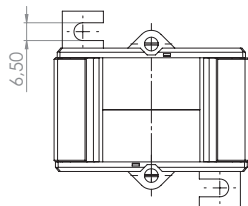
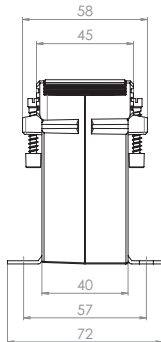
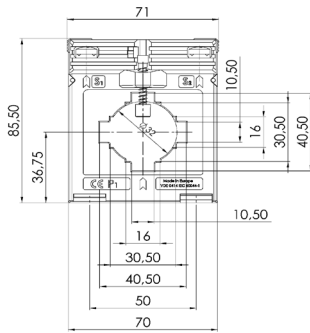

Primärstrom [A]	Bürde [VA]	Sekundärstrom [A] / Klasse			
		5 A Kl. 5P5 Best.-Nr.	5 A Kl. 10P5 Best.-Nr.	1 A Kl. 5P5 Best.-Nr.	1 A Kl. 10P5 Best.-Nr.
100	1	S24-1306B	S24-1307B	S24-1316B	S24-1317B
120	1	S24-1406B	S24-1407B	S24-1416B	S24-1417B
125	1	S24-1506B	S24-1507B	S24-1516B	S24-1517B
150	1	S24-1606B	S24-1607B		
	1,5		S24-1607C	S24-1616C	S24-1617C
200	1,5	S24-1706C	S24-1707C	S24-1716C	S24-1717C
	1,5	S24-1806C	S24-1807C	S24-1816C	S24-1817C
250	2,5		S24-1807D	S24-1816D	S24-1817D
	1,5	S24-1906C	S24-1907C	S24-1916C	S24-1917C
300	2,5	S24-1906D	S24-1907D	S24-1916D	S24-1917D
	1,5	S24-2006C	S24-2007C	S24-2016C	S24-2017C
400	2,5	S24-2006D	S24-2007D	S24-2016D	S24-2017D
	1,5	S24-2106C	S24-2107C	S24-2116C	S24-2117C
500	2,5			S24-2116D	S24-2117D
	1,5	S24-2206C	S24-2207C	S24-2216C	S24-2217C
600	2,5			S24-2216D	S24-2217D
	1,5	S24-2306C	S24-2307C	S24-2316C	S24-2317C
750	2,5		S24-2307D	S24-2316D	S24-2317D

		Best.-Nr.
	Schnappbefestigung Form D	55012
	Plombierplatte Form B	59041

SASK 41.6



Schutz-Aufsteck-Stromwandler

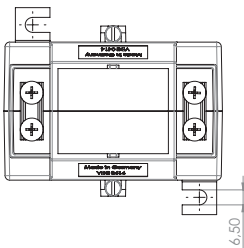
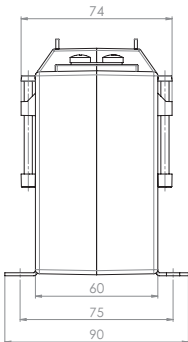
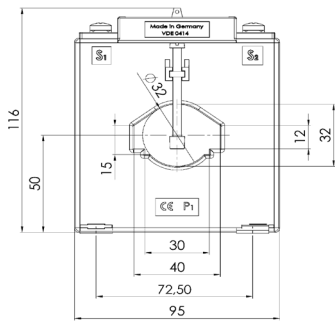

- Schiene 1 40 x 12 mm
- Schiene 2 30 x 15 mm
- Rundleiter 32 mm
- Baubreite 95 mm
- Bauhöhe 116 mm
- Bautiefe gesamt 74 mm



Primärstrom [A]	Bürde [VA]	Sekundärstrom [A] / Klasse			
		5 A Kl. 5P5 Best.-Nr.	5 A Kl. 10P5 Best.-Nr.	5 A Kl. 5P10 Best.-Nr.	5 A Kl. 10P10 Best.-Nr.
75	1,5	S30-1106C	S30-1107C	S30-1108C	S30-1109C
	2,5	S30-1106D	S30-1107D		
100	1,5	S30-1306C	S30-1307C	S30-1308C	S30-1309C
	2,5	S30-1306D	S30-1307D	S30-1308D	S30-1309D
	5	S30-1306F	S30-1307F		
150	2,5	S30-1606D	S30-1607D	S30-1608D	S30-1609D
	5	S30-1606F	S30-1607F		
200	2,5	S30-1706D	S30-1707D	S30-1708D	S30-1709D
	5	S30-1706F	S30-1707F		S30-1709F
	7,5	S30-1706G	S30-1707G		
	10	S30-1706H	S30-1707H		
250	2,5	S30-1806D	S30-1807D	S30-1808D	S30-1809D
	5	S30-1806F	S30-1807F	S30-1808F	S30-1809F
	7,5	S30-1806G	S30-1807G		
	10	S30-1806H	S30-1807H		
300	2,5	S30-1906D	S30-1907D	S30-1908D	S30-1909D
	5	S30-1906F	S30-1907F	S30-1908F	S30-1909F
	7,5	S30-1906G	S30-1907G		
	10	S30-1906H	S30-1907H		
	15		S30-1906J		
400	2,5	S30-2006D	S30-2007D	S30-2008D	S30-2009D
	5	S30-2006F	S30-2007F	S30-2008F	S30-2009F
	7,5	S30-2006G	S30-2007G	S30-2008G	S30-2009G
	10	S30-2006H	S30-2007H		
	15	S30-2006J	S30-2007J		
500	2,5	S30-2106D	S30-2107D	S30-2108D	S30-2109D
	5	S30-2106F	S30-2107F	S30-2108F	S30-2109F
	7,5	S30-2106G	S30-2107G	S30-2108G	S30-2109G
	10	S30-2106H	S30-2107H	S30-2108H	S30-2109H
	15	S30-2106J	S30-2107J		
600	2,5	S30-2206D	S30-2207D	S30-2208D	S30-2209D
	5	S30-2206F	S30-2207F	S30-2208F	S30-2209F
	7,5	S30-2206G	S30-2207G	S30-2208G	S30-2209G
	10	S30-2206H	S30-2207H	S30-2208H	S30-2209H
	15	S30-2206J	S30-2207J		
750	2,5	S30-2306D	S30-2307D	S30-2308D	S30-2309D
	5	S30-2306F	S30-2307F	S30-2308F	S30-2309F
	7,5	S30-2306G	S30-2307G	S30-2308G	S30-2309G
	10	S30-2306H	S30-2307H	S30-2308H	S30-2309H
	15	S30-2306J	S30-2307J		

	Schnappbefestigung	Best.-Nr. —
	Plombierplatte Form E	59044

SASK 41.6



Schutz-Aufsteck-Stromwandler

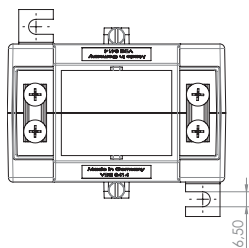
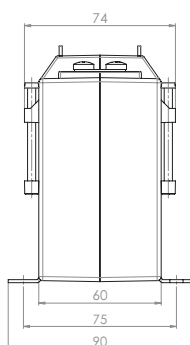
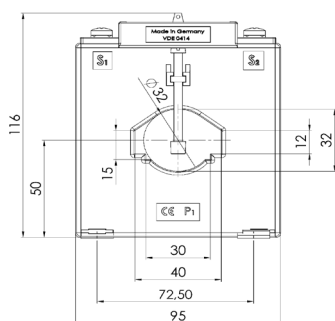

Schiene 1 40 x 12 mm
 Schiene 2 30 x 15 mm
 Rundleiter 32 mm
 Baubreite 95 mm
 Bauhöhe 116 mm
 Bautiefe gesamt 74 mm



Primärstrom [A]	Bürde [VA]	Sekundärstrom [A] / Klasse			
		1 A Kl. 5P5 Best.-Nr.	1 A Kl. 10P5 Best.-Nr.	1 A Kl. 5P10 Best.-Nr.	1 A Kl. 10P10 Best.-Nr.
75	1,5	S30-1116C	S30-1117C	S30-1118C	S30-1119C
	2,5	S30-1116D	S30-1117D		
100	1,5	S30-1316C	S30-1317C	S30-1318C	S30-1319C
	2,5	S30-1316D	S30-1317D	S30-1318D	S30-1319D
	5	S30-1316F	S30-1317F		
150	2,5	S30-1616D	S30-1617D	S30-1618D	S30-1619D
	5	S30-1616F	S30-1617F		
	7,5		S30-1617G		
200	2,5	S30-1716D		S30-1718D	S30-1719D
	5	S30-1716F	S30-1717F		S30-1719F
	7,5	S30-1716G	S30-1717G		
	10	S30-1716H	S30-1717H		
250	2,5	S30-1816D	S30-1817D	S30-1818D	S30-1819D
	5	S30-1816F	S30-1817F	S30-1818F	S30-1819F
	7,5	S30-1816G	S30-1817G		
	10	S30-1816H	S30-1817H		
300	2,5	S30-1916D	S30-1917D	S30-1918D	S30-1919D
	5	S30-1916F	S30-1917F	S30-1918F	S30-1919F
	7,5	S30-1916G	S30-1917G		
	10	S30-1916H	S30-1917H		
	15		S30-1916J		
400	2,5	S30-2016D	S30-2017D	S30-2018D	S30-2019D
	5	S30-2016F	S30-2017F	S30-2018F	S30-2019F
	7,5	S30-2016G	S30-2017G	S30-2018G	S30-2019G
	10	S30-2016H	S30-2017H		
	15	S30-2016J	S30-2017J		
500	2,5	S30-2116D	S30-2117D	S30-2118D	S30-2119D
	5	S30-2116F	S30-2117F	S30-2118F	S30-2119F
	7,5	S30-2116G	S30-2117G	S30-2118G	S30-2119G
	10	S30-2116H	S30-2117H	S30-2118H	S30-2119H
	15	S30-2116J	S30-2117J		
600	2,5	S30-2216D	S30-2217D	S30-2218D	S30-2219D
	5	S30-2216F	S30-2217F	S30-2218F	S30-2219F
	7,5	S30-2216G	S30-2217G	S30-2218G	S30-2219G
	10	S30-2216H	S30-2217H	S30-2218H	S30-2219H
	15	S30-2216J	S30-2217J		
750	2,5	S30-2316D	S30-2317D	S30-2318D	S30-2319D
	5	S30-2316F	S30-2317F	S30-2318F	S30-2319F
	7,5	S30-2316G	S30-2317G	S30-2318G	S30-2319G
	10	S30-2316H	S30-2317H	S30-2318H	S30-2319H
	15	S30-2316J	S30-2317J		

		Best.-Nr.
	Schnappbefestigung	–
	Plombierplatte Form E	59044

SASK 41.10

Schutz-Aufsteck-Stromwandler



Schiene 1 40 x 10 mm
 Rundleiter 32 mm
 Baubreite 150 mm
 Bauhöhe 175,5 mm
 Bautiefe gesamt 114 mm

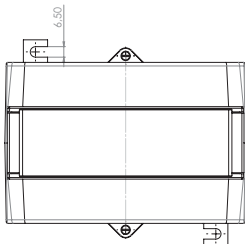
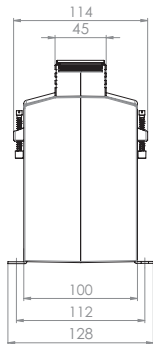
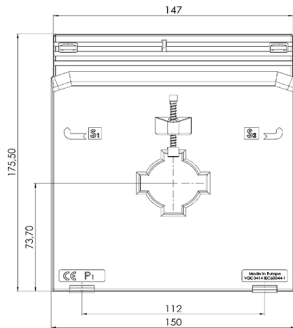

Primärstrom [A]	Bürde [VA]	Sekundärstrom [A] / Klasse			
		5 A Kl. 5P5 Best.-Nr.	5 A Kl. 10P5 Best.-Nr.	5 A Kl. 5P10 Best.-Nr.	5 A Kl. 10P10 Best.-Nr.
75	2,5	S31-1106D	S31-1107D		
	5		S31-1107F		
100	5	S31-1306F	S31-1307F	S31-1308F	S31-1309F
	7,5	S31-1306G	S31-1307G		
	10		S31-1307H		
150	5	S31-1606F	S31-1607F	S31-1608F	S31-1609F
	7,5	S31-1606G	S31-1607G	S31-1608G	S31-1609G
	10	S31-1606H	S31-1607H		
	15	S31-1606J	S31-1607J		
200	5	S31-1706F	S31-1707F	S31-1708F	S31-1709F
	7,5	S31-1706G	S31-1707G	S31-1708G	S31-1709G
	10	S31-1706H	S31-1707H	S31-1708H	S31-1709H
	15	S31-1706J	S31-1707J		
250	5	S31-1806F	S31-1807F	S31-1808F	S31-1809F
	7,5	S31-1806G	S31-1807G	S31-1808G	S31-1809G
	10	S31-1806H	S31-1807H	S31-1808H	S31-1809H
	15	S31-1806J	S31-1807J		
300	5	S31-1906F	S31-1907F	S31-1908F	S31-1909F
	7,5	S31-1906G	S31-1907G	S31-1908G	S31-1909G
	10	S31-1906H	S31-1907H	S31-1908H	S31-1909H
	15	S31-1906J	S31-1907J	S31-1908J	S31-1909J
	30	S31-1906L	S31-1907L		
400	5	S31-2006F	S31-2007F	S31-2008F	S31-2009F
	7,5	S31-2006G	S31-2007G	S31-2008G	S31-2009G
	10	S31-2006H	S31-2007H	S31-2008H	S31-2009H
	15	S31-2006J	S31-2007J	S31-2008J	S31-2009J
	30	S31-2006L	S31-2007L		
500	5	S31-2106F	S31-2107F	S31-2108F	S31-2109F
	7,5	S31-2106G	S31-2107G	S31-2108G	S31-2109G
	10	S31-2106H	S31-2107H	S31-2108H	S31-2109H
	15	S31-2106J	S31-2107J	S31-2108J	S31-2109J
	30	S31-2106L	S31-2107L		
600	5	S31-2206F	S31-2207F	S31-2208F	S31-2209F
	7,5	S31-2206G	S31-2207G	S31-2208G	S31-2209G
	10	S31-2206H	S31-2207H	S31-2208H	S31-2209H
	15	S31-2206J	S31-2207J	S31-2208J	S31-2209J
	30	S31-2206L	S31-2207L		
750	5	S31-2306F	S31-2307F	S31-2308F	S31-2309F
	7,5	S31-2306G	S31-2307G	S31-2308G	S31-2309G
	10	S31-2306H	S31-2307H	S31-2308H	S31-2309H
	15	S31-2306J	S31-2307J	S31-2308J	S31-2309J
	30	S31-2306L	S31-2307L		
800	5	S31-2406F	S31-2407F	S31-2408F	S31-2409F
	7,5	S31-2406G	S31-2407G	S31-2408G	S31-2409G
	10	S31-2406H	S31-2407H	S31-2408H	S31-2409H
	15	S31-2406J	S31-2407J	S31-2408J	S31-2409J
	30	S31-2406L	S31-2407L		

SASK 41.10



Schutz-Aufsteck-Stromwandler

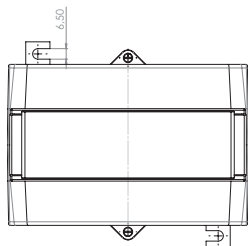
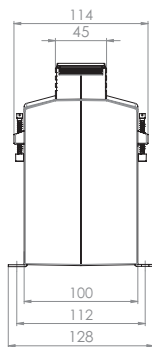
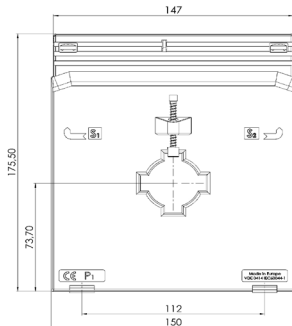

Schiene 1 40 x 10 mm
 Rundleiter 32 mm
 Baubreite 150 mm
 Bauhöhe 175,5 mm
 Bautiefe gesamt 114 mm



Primärstrom [A]	Bürde [VA]	Sekundärstrom [A] / Klasse			
		5 A Kl. 5P15 Best.-Nr.	5 A Kl. 10P15 Best.-Nr.	5 A Kl. 5P20 Best.-Nr.	5 A Kl. 10P20 Best.-Nr.
100	2,5	S31-130AD	S31-130BD		
150	2,5	S31-160AD	S31-160BD	S31-160CD	S31-160DD
	5	S31-160AF	S31-160BF		
200	5	S31-170AF	S31-170BF	S31-170CF	S31-170DF
250	5	S31-180AF	S31-180BF	S31-180CF	S31-180DF
300	5	S31-190AF	S31-190BF	S31-190CF	S31-190DF
	7,5	S31-190AG	S31-190BG		
400	10	S31-190AH	S31-190BH		
	5	S31-200AF	S31-200BF	S31-200CF	S31-200DF
500	7,5	S31-200AG	S31-200BG	S31-200CG	S31-200DG
	10	S31-200AH	S31-200BH	S31-200CH	S31-200DH
600	5	S31-210AF	S31-210BF	S31-210CF	S31-210DF
	7,5	S31-210AG	S31-210BG	S31-210CG	S31-210DG
750	10	S31-210AH	S31-210BH	S31-210CH	S31-210DH
	15	S31-210AJ	S31-210BJ		
800	5	S31-220AF	S31-220BF	S31-220CF	S31-220DF
	7,5	S31-220AG	S31-220BG	S31-220CG	S31-220DG
900	10	S31-220AH	S31-220BH	S31-220CH	S31-220DH
	15	S31-220AJ	S31-220BJ		
1000	5	S31-230AF	S31-230BF	S31-230CF	S31-230DF
	7,5	S31-230AG	S31-230BG	S31-230CG	S31-230DG
1200	10	S31-230AH	S31-230BH	S31-230CH	S31-230DH
	15	S31-230AJ	S31-230BJ		
1500	5	S31-240AF	S31-240BF	S31-240CF	S31-240DF
	7,5	S31-240AG	S31-240BG	S31-240CG	S31-240DG
1800	10	S31-240AH	S31-240BH	S31-240CH	S31-240DH
	15	S31-240AJ	S31-240BJ		

		Best.-Nr.
	Schnappbefestigung	–
	Plombierplatte	–

SASK 41.10

Schutz-Aufsteck-Stromwandler



Schiene 1 40 x 10 mm
 Rundleiter 32 mm
 Baubreite 150 mm
 Bauhöhe 175,5 mm
 Bautiefe gesamt 114 mm

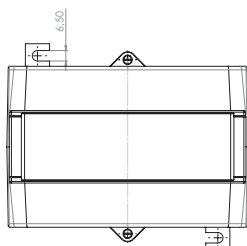
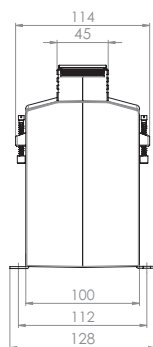
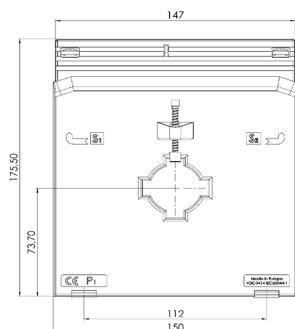

Primärstrom [A]	Bürde [VA]	Sekundärstrom [A] / Klasse			
		1 A Kl. 5P5 Best.-Nr.	1 A Kl. 10P5 Best.-Nr.	1 A Kl. 5P10 Best.-Nr.	1 A Kl. 10P10 Best.-Nr.
75	2,5	S31-1116D	S31-1117D		
	5		S31-1117F		
100	5	S31-1316F	S31-1317F	S31-1318F	S31-1319F
	7,5	S31-1316G	S31-1317G		
	10	S31-1316H	S31-1317H		
150	5	S31-1616F	S31-1617F	S31-1618F	S31-1619F
	7,5	S31-1616G	S31-1617G	S31-1618G	S31-1619G
	10	S31-1616H	S31-1617H		
	15	S31-1616J	S31-1617J		
200	5	S31-1716F	S31-1717F	S31-1718F	S31-1719F
	7,5	S31-1716G	S31-1717G	S31-1718G	S31-1719G
	10	S31-1716H	S31-1717H	S31-1718H	S31-1719H
	15	S31-1716J	S31-1717J		
250	5	S31-1816F	S31-1817F	S31-1818F	S31-1819F
	7,5	S31-1816G	S31-1817G	S31-1818G	S31-1819G
	10	S31-1816H	S31-1817H	S31-1818H	S31-1819H
	15	S31-1816J	S31-1817J		
300	5	S31-1916F	S31-1917F	S31-1918F	S31-1919F
	7,5	S31-1916G	S31-1917G	S31-1918G	S31-1919G
	10	S31-1916H	S31-1917H	S31-1918H	S31-1919H
	15	S31-1916J	S31-1917J	S31-1918J	S31-1919J
	30	S31-1916L	S31-1917L		
400	5	S31-2016F	S31-2017F	S31-2018F	S31-2019F
	7,5	S31-2016G	S31-2017G	S31-2018G	S31-2019G
	10	S31-2016H	S31-2017H	S31-2018H	S31-2019H
	15	S31-2016J	S31-2017J	S31-2018J	S31-2019J
	30	S31-2016L	S31-2017L		
500	5	S31-2116F	S31-2117F	S31-2118F	S31-2119F
	7,5	S31-2116G	S31-2117G	S31-2118G	S31-2119G
	10	S31-2116H	S31-2117H	S31-2118H	S31-2119H
	15	S31-2116J	S31-2117J	S31-2118J	S31-2119J
	30	S31-2116L	S31-2117L		
600	5	S31-2216F	S31-2217F	S31-2218F	S31-2219F
	7,5	S31-2216G	S31-2217G	S31-2218G	S31-2219G
	10	S31-2216H	S31-2217H	S31-2218H	S31-2219H
	15	S31-2216J	S31-2217J	S31-2218J	S31-2219J
	30	S31-2216L	S31-2217L		
750	5	S31-2316F	S31-2317F	S31-2318F	S31-2319F
	7,5	S31-2316G	S31-2317G	S31-2318G	S31-2319G
	10	S31-2316H	S31-2317H	S31-2318H	S31-2319H
	15	S31-2316J	S31-2317J	S31-2318J	S31-2319J
	30	S31-2316L	S31-2317L		
800	5	S31-2416F	S31-2417F	S31-2418F	S31-2419F
	7,5	S31-2416G	S31-2417G	S31-2418G	S31-2419G
	10	S31-2416H	S31-2417H	S31-2418H	S31-2419H
	15	S31-2416J	S31-2417J	S31-2418J	S31-2419J
	30	S31-2416L	S31-2417L		

SASK 41.10



Schutz-Aufsteck-Stromwandler

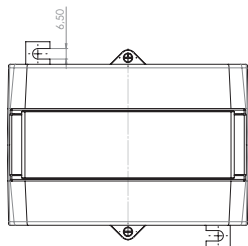
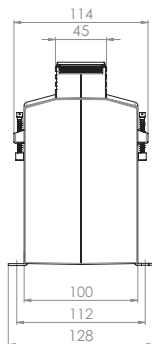
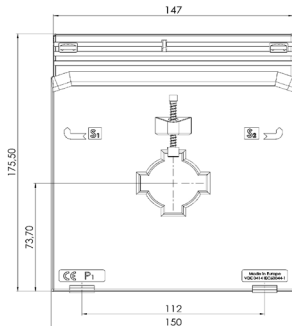

Schiene 1 40 x 10 mm
 Rundleiter 32 mm
 Baubreite 150 mm
 Bauhöhe 175,5 mm
 Bautiefe gesamt 114 mm



Primärstrom [A]	Bürde [VA]	Sekundärstrom [A] / Klasse			
		1 A Kl. 5P15 Best.-Nr.	1 A Kl. 10P15 Best.-Nr.	1 A Kl. 5P20 Best.-Nr.	1 A Kl. 10P20 Best.-Nr.
100	2,5	S31-131AD	S31-131BD		
150	2,5	S31-161AD	S31-161BD	S31-161CD	S31-161DD
	5	S31-161AF	S31-161BF		
200	5	S31-171AF	S31-171BF	S31-171CF	S31-171DF
250	5	S31-181AF	S31-181BF	S31-181CF	S31-181DF
300	5	S31-191AF	S31-191BF	S31-191CF	S31-191DF
	7,5	S31-191AG	S31-191BG		
	10	S31-191AH	S31-191BH		
400	5	S31-201AF	S31-201BF	S31-201CF	S31-201DF
	7,5	S31-201AG	S31-201BG	S31-201CG	S31-201DG
	10	S31-201AH	S31-201BH	S31-201CH	S31-201DH
500	5	S31-211AF	S31-211BF	S31-211CF	S31-211DF
	7,5	S31-211AG	S31-211BG	S31-211CG	S31-211DG
	10	S31-211AH	S31-211BH	S31-211CH	S31-211DH
	15	S31-211AJ	S31-211BJ		
600	5	S31-221AF	S31-221BF	S31-221CF	S31-221DF
	7,5	S31-221AG	S31-221BG	S31-221CG	S31-221DG
	10	S31-221AH	S31-221BH	S31-221CH	S31-221DH
750	15	S31-221AJ	S31-221BJ		
	5	S31-231AF	S31-231BF	S31-231CF	S31-231DF
	7,5	S31-231AG	S31-231BG	S31-231CG	S31-231DG
800	10	S31-231AH	S31-231BH	S31-231CH	S31-231DH
	15	S31-231AJ	S31-231BJ		
	5	S31-241AF	S31-241BF	S31-241CF	S31-241DF
800	7,5	S31-241AG	S31-241BG	S31-241CG	S31-241DG
	10	S31-241AH	S31-241BH	S31-241CH	S31-241DH
	15	S31-241AJ	S31-241BJ		

		Best.-Nr.
	Schnappbefestigung	–
	Plombierplatte	–

SASK 541.4

Schutz-Aufsteck-Stromwandler



Schiene 1	40 x 10 mm
Schiene 2	2 x 30 x 5 mm
Rundleiter	32 mm
Baubreite	86 mm
Bauhöhe	98,5 mm
Bautiefe gesamt	58 mm

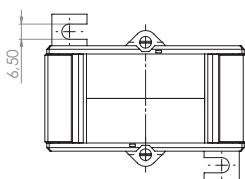
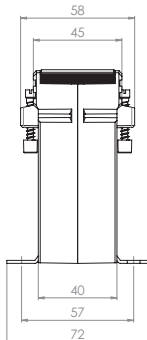
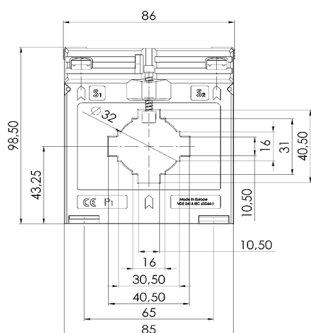

Primärstrom [A]	Bürde [VA]	Sekundärstrom [A] / Klasse			
		5 A Kl. 5P5 Best.-Nr.	5 A Kl. 10P5 Best.-Nr.	5 A Kl. 5P10 Best.-Nr.	5 A Kl. 10P10 Best.-Nr.
100	1	S33-1306B	S33-1307B		
	1,5	S33-1306C	S33-1307C		
125	1	S33-1506B	S33-1507B		
	1,5	S33-1506C	S33-1507C		
	2,5		S33-1507D		
150	1,5	S33-1606C	S33-1607C		
	2,5	S33-1606D	S33-1607D		
200	1,5	S33-1706C	S33-1707C		
	2,5	S33-1706D	S33-1707D		
250	1,5	S33-1806C	S33-1807C		S33-1809C
	2,5	S33-1806D	S33-1807D		
300	1,5	S33-1906C	S33-1907C	S33-1908C	S33-1909C
	2,5	S33-1906D	S33-1907D		
	5		S33-1907F		
400	1,5	S33-2006C	S33-2007C	S33-2008C	S33-2009C
	2,5	S33-2006D	S33-2007D		
	5	S33-2006F	S33-2007F		
500	1,5	S33-2106C	S33-2107C	S33-2108C	S33-2109C
	2,5	S33-2106D	S33-2107D	S33-2108D	S33-2109D
	5	S33-2106F	S33-2107F		
	7,5		S33-2107G		
600	1,5	S33-2206C	S33-2207C	S33-2208C	S33-2209C
	2,5	S33-2206D	S33-2207D	S33-2208D	S33-2209D
	5	S33-2206F	S33-2207F		
	7,5		S33-2207G		
750	2,5	S33-2306D	S33-2307D	S33-2308D	S33-2309D
	5	S33-2306F	S33-2307F		
	7,5	S33-2306G	S33-2307G		
	10	S33-2306H	S33-2307H		
1000	2,5	S33-2506D	S33-2507D	S33-2508D	S33-2509D
	5	S33-2506F	S33-2507F		
	7,5	S33-2506G	S33-2507G		
	10	S33-2506H	S33-2507H		

		Best.-Nr.
	Schnappbefestigung	–
	Plombierplatte Form C	59042

SASK 541.4



Schutz-Aufsteck-Stromwandler

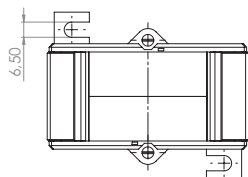
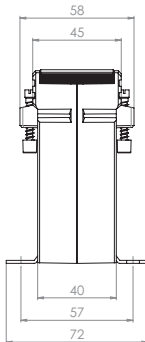
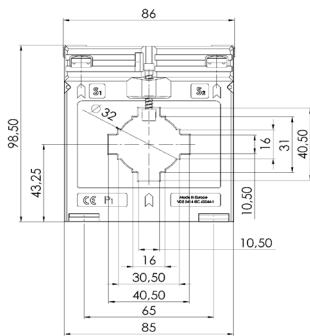

Schiene 1	40 x 10 mm
Schiene 2	2 x 30 x 5 mm
Rundleiter	32 mm
Baubreite	86 mm
Bauhöhe	98,5 mm
Bautiefe gesamt	58 mm



Primärstrom [A]	Bürde [VA]	Sekundärstrom [A] / Klasse			
		1 A Kl. 5P5 Best.-Nr.	1 A Kl. 10P5 Best.-Nr.	1 A Kl. 5P10 Best.-Nr.	1 A Kl. 10P10 Best.-Nr.
100	1	S33-1316B	S33-1317B		
	1,5	S33-1316C	S33-1317C		
125	1	S33-1516B	S33-1517B		
	1,5	S33-1516C	S33-1517C		
	2,5	S33-1516D	S33-1517D		
150	1,5	S33-1616C	S33-1617C		
	2,5	S33-1616D	S33-1617D		
200	1,5	S33-1716C	S33-1717C		
	2,5	S33-1716D	S33-1717D		
250	1,5	S33-1816C	S33-1817C	S33-1818C	S33-1819C
	2,5	S33-1816D	S33-1817D		
300	1,5	S33-1916C	S33-1917C	S33-1918C	S33-1919C
	2,5	S33-1916D	S33-1917D		
	5		S33-1917F		
400	1,5	S33-2016C	S33-2017C	S33-2018C	S33-2019C
	2,5	S33-2016D	S33-2017D		
	5	S33-2016F	S33-2017F		
500	1,5	S33-2116C	S33-2117C	S33-2118C	S33-2119C
	2,5	S33-2116D	S33-2117D	S33-2118D	S33-2119D
	5	S33-2116F	S33-2117F		
600	1,5	S33-2216C	S33-2217C	S33-2218C	S33-2219C
	2,5	S33-2216D	S33-2217D	S33-2218D	S33-2219D
	5	S33-2216F	S33-2217F		
	7,5		S33-2217G		
750	1,5	S33-2316C	S33-2317C	S33-2318C	S33-2319C
	2,5	S33-2316D	S33-2317D	S33-2318D	S33-2319D
	5	S33-2316F	S33-2317F		
	7,5	S33-2316G	S33-2317G		
	10	S33-2316H	S33-2317H		
1000	2,5	S33-2516D	S33-2517D	S33-2518D	S33-2519D
	5	S33-2516F	S33-2517F		S33-2519F
	7,5	S33-2516G	S33-2517G		
	10	S33-2516H	S33-2517H		

		Best.-Nr.
	Schnappbefestigung	–
	Plombierplatte Form C	59042

SASK 51.4

Schutz-Aufsteck-Stromwandler



Schiene 1 50 x 12 mm
 Schiene 2 2 x 40 x 10 mm
 Rundleiter 44 mm
 Baubreite 86 mm
 Bauhöhe 98,5 mm
 Bautiefe gesamt 58 mm

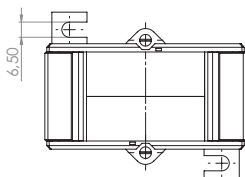
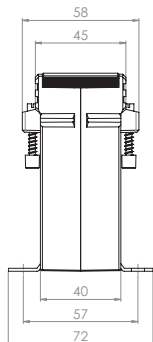
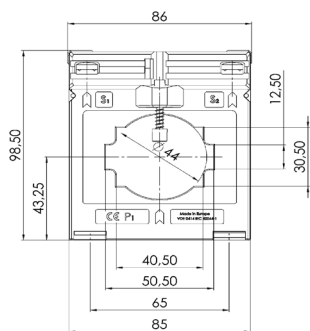

Primärstrom [A]	Bürde [VA]	Sekundärstrom [A] / Klasse			
		5 A Kl. 5P5 Best.-Nr.	5 A Kl. 10P5 Best.-Nr.	1 A Kl. 5P5 Best.-Nr.	1 A Kl. 10P5 Best.-Nr.
150	1			S34-1616B	S34-1617B
200	1	S34-1706B	S34-1707B	S34-1716B	S34-1717B
	1,5		S34-1707C	S34-1716C	S34-1717C
250	1,5	S34-1806C	S34-1807C	S34-1816C	S34-1817C
	2,5				S34-1817D
300	1,5	S34-1906C	S34-1907C	S34-1916C	S34-1917C
	2,5			S34-1916D	S34-1917D
400	1,5	S34-2006C	S34-2007C	S34-2016C	S34-2017C
	2,5		S34-2007D	S34-2016D	S34-2017D
500	1,5	S34-2106C	S34-2107C	S34-2116C	S34-2117C
	2,5		S34-2107D	S34-2116D	S34-2117D
600	1,5	S34-2206C	S34-2207C	S34-2216C	S34-2217C
	2,5		S34-2207D	S34-2216D	S34-2217D
750	1,5	S34-2306C	S34-2307C	S34-2316C	S34-2317C
	2,5	S34-2306D	S34-2307D	S34-2316D	S34-2317D
1000	1,5	S34-2506C	S34-2507C	S34-2516C	S34-2517C
	2,5	S34-2506D	S34-2507D	S34-2516D	S34-2517D

		Best.-Nr.
	Schnappbefestigung	—
	Plombierplatte Form C	59042

SASK 51.6



Schutz-Aufsteck-Stromwandler

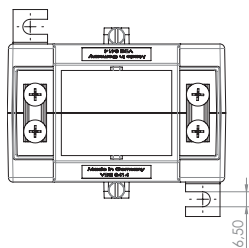
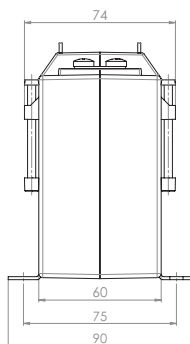
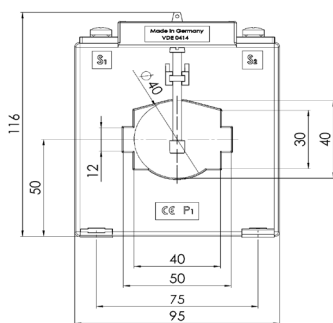

Schiene 1 50 x 12 mm
 Schiene 2 40 x 30 mm
 Rundleiter 40 mm
 Baubreite 95 mm
 Bauhöhe 116 mm
 Bautiefe gesamt 74 mm



Primärstrom [A]	Bürde [VA]	Sekundärstrom [A] / Klasse			
		5 A Kl. 5P5 Best.-Nr.	5 A Kl. 10P5 Best.-Nr.	5 A Kl. 5P10 Best.-Nr.	5 A Kl. 10P10 Best.-Nr.
150	1,5	S37-1606C	S37-1607C	S37-1608C	S37-1609C
	2,5	S37-1606D	S37-1607D		S37-1609D
	5	S37-1606F	S37-1607F		
200	1,5	S37-1706C	S37-1707C	S37-1708C	S37-1709C
	2,5	S37-1706D	S37-1707D	S37-1708D	S37-1709D
	5	S37-1706F	S37-1707F		
250	2,5	S37-1806D	S37-1807D	S37-1808D	S37-1809D
	5	S37-1806F	S37-1807F		
	7,5		S37-1807G		
300	2,5	S37-1906D	S37-1907D	S37-1908D	S37-1909D
	5	S37-1906F	S37-1907F		
	7,5	S37-1906G	S37-1907G		
	10		S37-1907H		
400	2,5	S37-2006D	S37-2007D	S37-2008D	S37-2009D
	5	S37-2006F	S37-2007F	S37-2008F	S37-2009F
	7,5	S37-2006G	S37-2007G		
	10	S37-2006H	S37-2007H		
500	2,5	S37-2106D	S37-2107D	S37-2108D	S37-2109D
	5	S37-2106F	S37-2107F	S37-2108F	S37-2109F
	7,5	S37-2106G	S37-2107G		
	10	S37-2106H	S37-2107H		
	15		S37-2107J		
600	2,5	S37-2206D	S37-2207D	S37-2208D	S37-2209D
	5	S37-2206F	S37-2207F	S37-2208F	S37-2209F
	7,5	S37-2206G	S37-2207G		
	10	S37-2206H	S37-2207H		
	15	S37-2206J	S37-2207J		
750	2,5	S37-2306D	S37-2307D	S37-2308D	S37-2309D
	5	S37-2306F	S37-2307F	S37-2308F	S37-2309F
	7,5	S37-2306G	S37-2307G	S37-2308G	S37-2309G
	10	S37-2306H	S37-2307H		
	15	S37-2306J	S37-2307J		
1000	2,5	S37-2506D	S37-2507D	S37-2508D	S37-2509D
	5	S37-2506F	S37-2507F	S37-2508F	S37-2509F
	7,5	S37-2506G	S37-2507G	S37-2508G	S37-2509G
	10	S37-2506H	S37-2507H		
	15	S37-2506J	S37-2507J		

		Best.-Nr.
	Schnappbefestigung	–
	Plombierplatte Form E	59044

SASK 51.6



Schutz-Aufsteck-Stromwandler

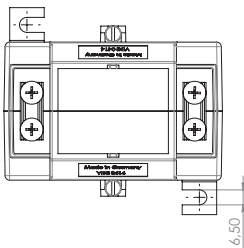
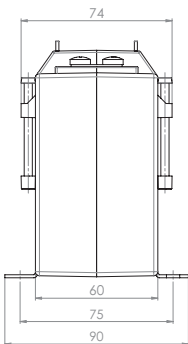
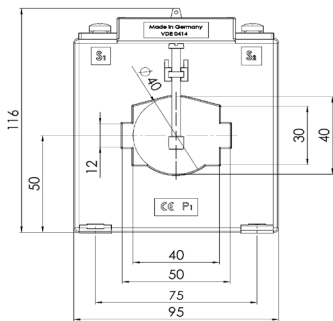

Schiene 1 50 x 12 mm
 Schiene 2 40 x 30 mm
 Rundleiter 40 mm
 Baubreite 95 mm
 Bauhöhe 116 mm
 Bautiefe gesamt 74 mm



Primärstrom [A]	Bürde [VA]	Sekundärstrom [A] / Klasse			
		1 A Kl. 5P5 Best.-Nr.	1 A Kl. 10P5 Best.-Nr.	1 A Kl. 5P10 Best.-Nr.	1 A Kl. 10P10 Best.-Nr.
150	1,5	S37-1616C	S37-1617C	S37-1618C	S37-1619C
	2,5	S37-1616D	S37-1617D		S37-1619D
	5	S37-1616F	S37-1617F		
200	1,5	S37-1716C	S37-1717C	S37-1718C	S37-1719C
	2,5	S37-1716D	S37-1717D	S37-1718D	S37-1719D
	5	S37-1716F	S37-1717F		
250	2,5	S37-1816D	S37-1817D	S37-1818D	S37-1819D
	5	S37-1816F	S37-1817F		
	7,5		S37-1817G		
300	2,5	S37-1916D	S37-1917D	S37-1918D	S37-1919D
	5	S37-1916F	S37-1917F		
	7,5		S37-1917G		
	10		S37-1917H		
400	2,5	S37-2016D	S37-2017D	S37-2018D	S37-2019D
	5	S37-2016F	S37-2017F	S37-2018F	S37-2019F
	7,5	S37-2016G	S37-2017G		
	10	S37-2016H	S37-2017H		
500	2,5	S37-2116D	S37-2117D	S37-2118D	S37-2119D
	5	S37-2116F	S37-2117F	S37-2118F	S37-2119F
	7,5	S37-2116G	S37-2117G		
	10	S37-2116H	S37-2117H		
600	15		S37-2117J		
	2,5	S37-2216D	S37-2217D	S37-2218D	S37-2219D
	5	S37-2216F	S37-2217F	S37-2218F	S37-2219F
	7,5	S37-2216G	S37-2217G		
	10	S37-2216H	S37-2217H		
750	15	S37-2216J	S37-2217J		
	2,5	S37-2316D	S37-2317D	S37-2318D	S37-2319D
	5	S37-2316F	S37-2317F	S37-2318F	S37-2319F
	7,5	S37-2316G	S37-2317G		
1000	10	S37-2316H	S37-2317H		
	15	S37-2316J	S37-2317J		
	2,5	S37-2516D	S37-2517D	S37-2518D	S37-2519D
	5	S37-2516F	S37-2517F	S37-2518F	S37-2519F
	7,5	S37-2516G	S37-2517G	S37-2518G	S37-2519G
1000	10	S37-2516H	S37-2517H		
	15	S37-2516J	S37-2517J		

		Best.-Nr.
	Schnappbefestigung	–
	Plombierplatte Form E	59044

SASK 61.4



Schutz-Aufsteck-Stromwandler

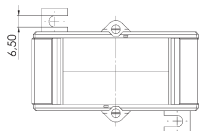
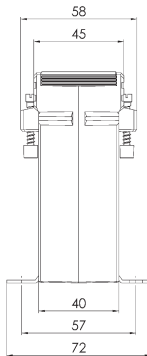
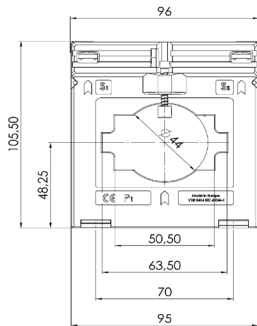

Schiene 1 60 x 10 mm
 Schiene 2 2 x 50 x 10 mm
 Rundleiter 44 mm
 Baubreite 96 mm
 Bauhöhe 105,5 mm
 Bautiefe gesamt 58 mm



Primärstrom [A]	Bürde [VA]	Sekundärstrom [A] / Klasse			
		5 A Kl. 5P5 Best.-Nr.	5 A Kl. 10P5 Best.-Nr.	1 A Kl. 5P5 Best.-Nr.	1 A Kl. 10P5 Best.-Nr.
200	1	S41-1706B	S41-1707B	S41-1716B	S41-1717B
	1,5	S41-1706C	S41-1707C	S41-1716C	S41-1717C
250	1	S41-1806B	S41-1807B	S41-1816B	S41-1817B
	1,5	S41-1806C	S41-1807C	S41-1816C	S41-1817C
300	1,5	S41-1906C	S41-1907C	S41-1916C	S41-1917C
	2,5		S41-1907D	S41-1916D	S41-1917D
400	1,5	S41-2006C	S41-2007C	S41-2016C	S41-2017C
	2,5	S41-2006D	S41-2007D	S41-2016D	S41-2017D
500	1,5	S41-2106C	S41-2107C	S41-2116C	S41-2117C
	2,5	S41-2106D	S41-2107D	S41-2116D	S41-2117D
600	1,5	S41-2206C	S41-2207C	S41-2216C	S41-2217C
	2,5	S41-2206D	S41-2207D	S41-2216D	S41-2217D
	5			S41-2216F	S41-2217F
750	1,5	S41-2306C	S41-2307C	S41-2316C	S41-2317C
	2,5	S41-2306D	S41-2307D	S41-2316D	S41-2317D
	5	S41-2307F		S41-2316F	S41-2317F
1000	1,5	S41-2506C	S41-2507C	S41-2516C	S41-2517C
	2,5	S41-2506D	S41-2507D	S41-2516D	S41-2517D
	5	S41-2506F	S41-2507F	S41-2516F	S41-2517F
1200	1,5	S41-2606C	S41-2607C	S41-2616C	S41-2617C
	2,5	S41-2606D	S41-2607D	S41-2616D	S41-2617D
	5	S41-2606F	S41-2607F	S41-2616F	S41-2617F
1250	1,5	S41-2706C	S41-2707C	S41-2716C	S41-2717C
	2,5	S41-2706D	S41-2707D	S41-2716D	S41-2717D
	5	S41-2706F	S41-2707F	S41-2716F	S41-2717F

		Best.-Nr.
	Schnappbefestigung	–
	Plombierplatte Form C	59042

SASK 61.10

Schutz-Aufsteck-Stromwandler



Schiene 1 60 x 10 mm
 Schiene 2 50 x 30 mm
 Baubreite 150 mm
 Bauhöhe 175,5 mm
 Bautiefe gesamt 114 mm

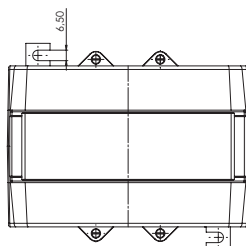
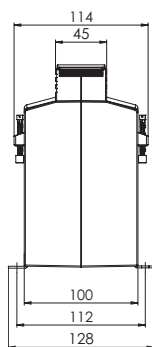
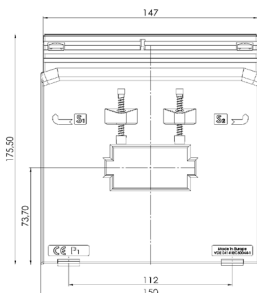

Primärstrom [A]	Bürde [VA]	Sekundärstrom [A] / Klasse			
		5 A Kl. 5P5 Best.-Nr.	5 A Kl. 10P5 Best.-Nr.	5 A Kl. 5P10 Best.-Nr.	5 A Kl. 10P10 Best.-Nr.
100	2,5	S50-1306D	S50-1307D	S50-1308D	S50-1309D
	5	S50-1306F	S50-1307F		
150	5	S50-1606F	S50-1607F	S50-1608F	S50-1609F
	7,5	S50-1606G	S50-1607G		
	10	S50-1606H	S50-1607H		
200	5	S50-1706F	S50-1707F	S50-1708F	S50-1709F
	7,5	S50-1706G	S50-1707G		
	10	S50-1706H	S50-1707H		
	15	S50-1706J	S50-1707J		
250	5	S50-1806F	S50-1807F	S50-1808F	S50-1809F
	7,5	S50-1806G	S50-1807G		S50-1809G
	10	S50-1806H	S50-1807H	S50-1908H	S50-1809H
	15	S50-1806J	S50-1807J		
300	5	S50-1906F	S50-1907F	S50-1908F	S50-1909F
	7,5	S50-1906G	S50-1907G	S50-1908G	S50-1909G
	10	S50-1906H	S50-1907H		S50-1909H
	15	S50-1906J	S50-1907J		
400	5	S50-2006F	S50-2007F	S50-2008F	S50-2009F
	7,5	S50-2006G	S50-2007G	S50-2008G	S50-2009G
	10	S50-2006H	S50-2007H	S50-2008H	S50-2009H
	15	S50-2006J	S50-2007J		S50-2009J
500	5	S50-2106F	S50-2107F	S50-2108F	S50-2109F
	7,5	S50-2106G	S50-2107G	S50-2108G	S50-2109G
	10	S50-2106H	S50-2107H	S50-2108H	S50-2109H
	15	S50-2106J	S50-2107J	S50-2108J	S50-2109J
600	5	S50-2206F	S50-2207F	S50-2208F	S50-2209F
	7,5	S50-2206G	S50-2207G	S50-2208G	S50-2209G
	10	S50-2206H	S50-2207H	S50-2208H	S50-2209H
	15	S50-2206J	S50-2207J	S50-2208J	S50-2209J
750	5	S50-2306F	S50-2307F	S50-2308F	S50-2309F
	7,5	S50-2306G	S50-2307G	S50-2308G	S50-2309G
	10	S50-2306H	S50-2307H	S50-2308H	S50-2309H
	15	S50-2306J	S50-2307J	S50-2308J	S50-2309J
1000	5	S50-2506F	S50-2507F	S50-2508F	S50-2509F
	7,5	S50-2506G	S50-2507G	S50-2508G	S50-2509G
	10	S50-2506H	S50-2507H	S50-2508H	S50-2509H
	15	S50-2506J	S50-2507J	S50-2508J	S50-2509J
1200	5	S50-2606F	S50-2607F	S50-2608F	S50-2609F
	7,5	S50-2606G	S50-2607G	S50-2608G	S50-2609G
	10	S50-2606H	S50-2607H	S50-2608H	S50-2609H
	15	S50-2606J	S50-2607J	S50-2608J	S50-2609J
1250	5	S50-2706F	S50-2707F	S50-2708F	S50-2709F
	7,5	S50-2706G	S50-2707G	S50-2708G	S50-2709G
	10	S50-2706H	S50-2707H	S50-2708H	S50-2709H
	15	S50-2706J	S50-2707J	S50-2708J	S50-2709J
1500	5	S50-2806F	S50-2807F	S50-2808F	S50-2809F
	7,5	S50-2806G	S50-2807G	S50-2808G	S50-2809G
	10	S50-2806H	S50-2807H	S50-2808H	S50-2809H
	15	S50-2806J	S50-2807J	S50-2808J	S50-2809J

SASK 61.10



Schutz-Aufsteck-Stromwandler

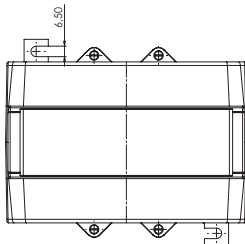
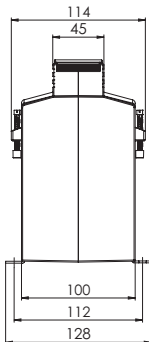
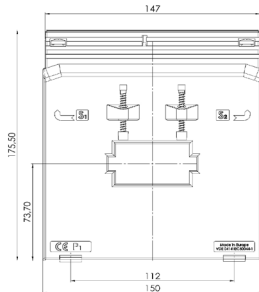

Schiene 1 60 x 10 mm
 Schiene 2 50 x 30 mm
 Baubreite 150 mm
 Bauhöhe 175,5 mm
 Bautiefe gesamt 114 mm



Primärstrom [A]	Bürde [VA]	Sekundärstrom [A] / Klasse			
		5 A Kl. 5P15 Best.-Nr.	5 A Kl. 10P15 Best.-Nr.	5 A Kl. 5P20 Best.-Nr.	5 A Kl. 10P20 Best.-Nr.
150	2,5	S50-160AD	S50-160BD		
200	2,5	S50-170AD	S50-170BD	S50-170CD	S50-170DD
250	2,5	S50-180AD	S50-180BD	S50-180CD	S50-180DD
	5	S50-180AF	S50-180BF		
300	2,5	S50-190AD	S50-190BD	S50-190CD	S50-190DD
	5	S50-190AF	S50-190BF		S50-190DF
400	5	S50-200AF	S50-200BF	S50-200CF	S50-200DF
500	5	S50-210AF	S50-210BF	S50-210CF	S50-210DF
	7,5	S50-210AG	S50-210BG		
	10	S50-210AH	S50-210BH		
600	5	S50-220AF	S50-220BF	S50-220CF	S50-220DF
	7,5	S50-220AG	S50-220BG		
	10	S50-220AH	S50-220BH		
750	5	S50-230AF	S50-230BF	S50-230CF	S50-230DF
	7,5	S50-230AG	S50-230BG		
	10	S50-230AH	S50-230BH		
1000	5	S50-250AF	S50-250BF	S50-250CF	S50-250DF
	7,5	S50-250AG	S50-250BG		
	10	S50-250AH	S50-250BH		
1200	5	S50-260AF	S50-260BF	S50-260CF	S50-260DF
	7,5	S50-260AG	S50-260BG		
	10	S50-260AH	S50-260BH		
1250	5	S50-270AF	S50-270BF	S50-270CF	S50-270DF
	7,5	S50-270AG	S50-270BG		
	10	S50-270AH	S50-270BH		
1500	5	S50-280AF	S50-280BF	S50-280CF	S50-280DF
	7,5	S50-280AG	S50-280BG		
	10	S50-280AH	S50-280BH		
	15		S50-280BJ		

		Best.-Nr.
	Schnappbefestigung	–
	Plombierplatte	–

SASK 61.10

Schutz-Aufsteck-Stromwandler



Schiene 1 60 x 10 mm
 Schiene 2 50 x 30 mm
 Baubreite 150 mm
 Bauhöhe 175,5 mm
 Bautiefe gesamt 114 mm

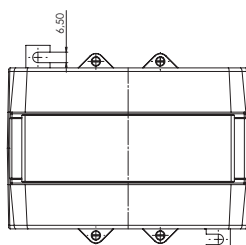
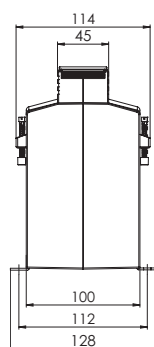
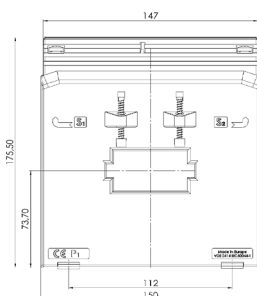

Primärstrom [A]	Bürde [VA]	Sekundärstrom [A] / Klasse			
		1 A Kl. 5P5 Best.-Nr.	1 A Kl. 10P5 Best.-Nr.	1 A Kl. 5P10 Best.-Nr.	1 A Kl. 10P10 Best.-Nr.
100	2,5	S50-1316D	S50-1317D	S50-1318D	S50-1319D
	5	S50-1316F	S50-1317F		
150	5	S50-1616F	S50-1617F	S50-1618F	S50-1619F
	7,5	S50-1616G	S50-1617G		
	10	S50-1616H	S50-1617H		
200	5	S50-1716F	S50-1717F	S50-1718F	S50-1719F
	7,5	S50-1716G	S50-1717G		
	10	S50-1716H	S50-1717H		
	15	S50-1716J	S50-1717J		
250	5	S50-1816F	S50-1817F	S50-1818F	S50-1819F
	7,5	S50-1816G	S50-1817G		S50-1819G
	10	S50-1816H	S50-1817H	S50-1918H	S50-1819H
	15	S50-1816J	S50-1817J		
300	5	S50-1916F	S50-1917F	S50-1918F	S50-1919F
	7,5	S50-1916G	S50-1917G	S50-1918G	S50-1919G
	10	S50-1916H	S50-1917H		S50-1919H
	15	S50-1916J	S50-1917J		
400	5	S50-2016F	S50-2017F	S50-2018F	S50-2019F
	7,5	S50-2016G	S50-2017G	S50-2018G	S50-2019G
	10	S50-2016H	S50-2017H	S50-2018H	S50-2019H
	15	S50-2016J	S50-2017J		S50-2019J
500	5	S50-2116F	S50-2117F	S50-2118F	S50-2119F
	7,5	S50-2116G	S50-2117G	S50-2118G	S50-2119G
	10	S50-2116H	S50-2117H	S50-2118H	S50-2119H
	15	S50-2116J	S50-2117J	S50-2118J	S50-2119J
600	5	S50-2216F	S50-2217F	S50-2218F	S50-2219F
	7,5	S50-2216G	S50-2217G	S50-2218G	S50-2219G
	10	S50-2216H	S50-2217H	S50-2218H	S50-2219H
	15	S50-2216J	S50-2217J	S50-2218J	S50-2219J
750	5	S50-2316F	S50-2317F	S50-2318F	S50-2319F
	7,5	S50-2316G	S50-2317G	S50-2318G	S50-2319G
	10	S50-2316H	S50-2317H	S50-2318H	S50-2319H
	15	S50-2316J	S50-2317J	S50-2318J	S50-2319J
1000	5	S50-2516F	S50-2517F	S50-2518F	S50-2519F
	7,5	S50-2516G	S50-2517G	S50-2518G	S50-2519G
	10	S50-2516H	S50-2517H	S50-2518H	S50-2519H
	15	S50-2516J	S50-2517J	S50-2518J	S50-2519J
1200	5	S50-2616F	S50-2617F	S50-2618F	S50-2619F
	7,5	S50-2616G	S50-2617G	S50-2618G	S50-2619G
	10	S50-2616H	S50-2617H	S50-2618H	S50-2619H
	15	S50-2616J	S50-2617J	S50-2618J	S50-2619J
1250	5	S50-2716F	S50-2717F	S50-2718F	S50-2719F
	7,5	S50-2716G	S50-2717G	S50-2718G	S50-2719G
	10	S50-2716H	S50-2717H	S50-2718H	S50-2719H
	15	S50-2716J	S50-2717J	S50-2718J	S50-2719J
1500	5	S50-2816F	S50-2817F	S50-2818F	S50-2819F
	7,5	S50-2816G	S50-2817G	S50-2818G	S50-2819G
	10	S50-2816H	S50-2817H	S50-2818H	S50-2819H
	15	S50-2816J	S50-2817J	S50-2818J	S50-2819J

SASK 61.10



Schutz-Aufsteck-Stromwandler

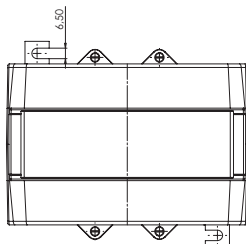
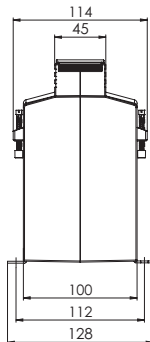
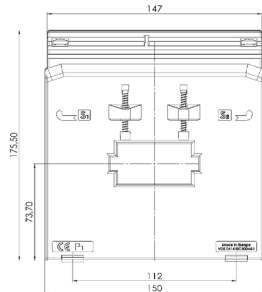

Schiene 1 60 x 10 mm
 Schiene 2 50 x 30 mm
 Baubreite 150 mm
 Bauhöhe 175,5 mm
 Bautiefe gesamt 114 mm



Primärstrom [A]	Bürde [VA]	Sekundärstrom [A] / Klasse			
		1 A Kl. 5P15 Best.-Nr.	1 A Kl. 10P15 Best.-Nr.	1 A Kl. 5P20 Best.-Nr.	1 A Kl. 10P20 Best.-Nr.
150	2,5	S50-161AD	S50-161BD		
200	2,5	S50-171AD	S50-171BD	S50-171CD	S50-171DD
250	2,5	S50-181AD	S50-181BD	S50-181CD	S50-181DD
	5	S50-181AF	S50-181BF		
300	2,5	S50-191AD	S50-191BD	S50-191CD	S50-191DD
	5	S50-191AF	S50-191BF		S50-191DF
400	5	S50-201AF	S50-201BF	S50-201CF	S50-201DF
500	5	S50-211AF	S50-211BF	S50-211CF	S50-211DF
	7,5	S50-211AG	S50-211BG		
	10	S50-211AH	S50-211BH		
600	5	S50-221AF	S50-221BF	S50-221CF	S50-221DF
	7,5	S50-221AG	S50-221BG		
	10	S50-221AH	S50-221BH		
750	5	S50-231AF	S50-231BF	S50-231CF	S50-231DF
	7,5	S50-231AG	S50-231BG		
	10	S50-231AH	S50-231BH		
1000	5	S50-251AF	S50-251BF	S50-251CF	S50-251DF
	7,5	S50-251AG	S50-251BG		
	10	S50-251AH	S50-251BH		
1200	5	S50-261AF	S50-261BF	S50-261CF	S50-261DF
	7,5	S50-261AG	S50-261BG		
	10	S50-261AH	S50-261BH		
1250	5	S50-271AF	S50-271BF	S50-271CF	S50-271DF
	7,5	S50-271AG	S50-271BG		
	10	S50-271AH	S50-271BH		
1500	5	S50-281AF	S50-281BF	S50-281CF	S50-281DF
	7,5	S50-281AG	S50-281BG		
	10	S50-281AH	S50-281BH		
	15		S50-281BJ		

		Best.-Nr.
	Schnappbefestigung	–
	Plombierplatte	–

SASK 63.6



Schutz-Aufsteck-Stromwandler

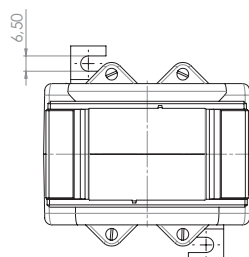
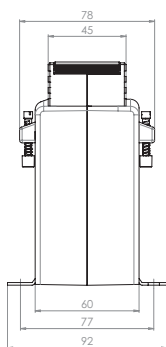
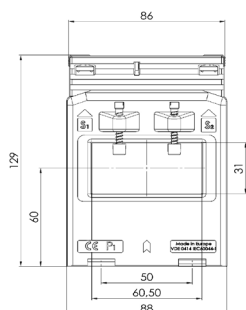

Schiene 1 60 x 30 mm
 Rundleiter 30 mm
 Baubreite 88 mm
 Bauhöhe 129 mm
 Bautiefe gesamt 78 mm



Primärstrom [A]	Bürde [VA]	Sekundärstrom [A] / Klasse			
		5 A Kl. 5P5 Best.-Nr.	5 A Kl. 10P5 Best.-Nr.	1 A Kl. 5P5 Best.-Nr.	1 A Kl. 10P5 Best.-Nr.
200	1,5	S46-1706C	S46-1707C	S46-1716C	S46-1717C
	2,5		S46-1707D	S46-1716D	S46-1717D
250	1,5	S46-1806C	S46-1807C	S46-1816C	S46-1817C
	2,5	S46-1806D	S46-1807D	S46-1816D	S46-1817D
300	1,5	S46-1906C	S46-1907C	S46-1916C	S46-1917C
	2,5	S46-1906D	S46-1907D	S46-1916D	S46-1917D
400	2,5	S46-2006D	S46-2007D	S46-2016D	S46-2017D
	5		S46-2007F	S46-2016F	S46-2017F
500	2,5	S46-2106D	S46-2107D	S46-2116D	S46-2117D
	5	S46-2106F	S46-2107F	S46-2116F	S46-2117F
600	2,5	S46-2206D	S46-2207D	S46-2216D	S46-2217D
	5	S46-2206F	S46-2207F	S46-2216F	S46-2217F
750	2,5	S46-2306D	S46-2307D	S46-2316D	S46-2317D
	5	S46-2306F	S46-2307F	S46-2316F	S46-2317F
1000	2,5	S46-2506D	S46-2507D	S46-2516D	S46-2517D
	5	S46-2506F	S46-2507F	S46-2516F	S46-2517F

		Best.-Nr.
	Schnappbefestigung	—
	Plombierplatte Form C	59042

Die passende Ausführung nicht gefunden?

Wir haben weitere Bauformen, in welchen wir Schutzwandler realisieren können!



- Höhere Primärströme
- Größere Schienenabmessungen
- Schutzklasse PX

Fragen Sie bei uns an!

Zusätzlich haben wir auch die Möglichkeit Ihren gewünschten Schutzwandler in einteiliger oder teilbarer Ausführung im Vollguss zu realisieren.

Bitte sehen Sie hierzu die nachstehenden Seiten.

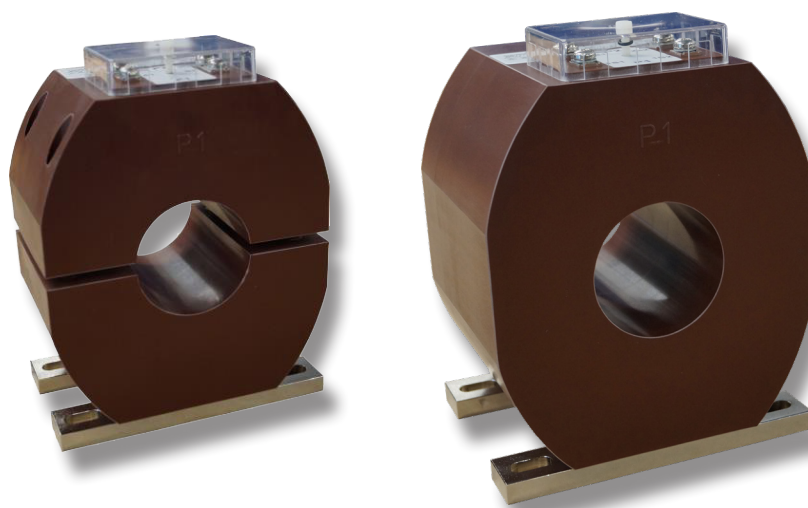

CTR

Einteiliger Stromwandler im Vollverguss für Innenraumanwendungen 0,72 kV / 1,2 kV

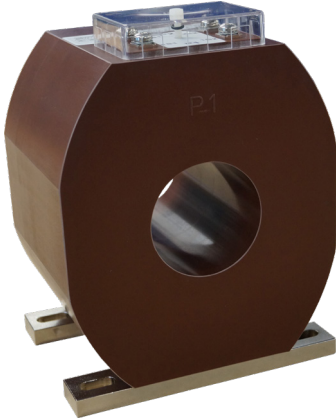

Merkmale / Nutzen

- Einteiliger Stromwandler der je nach Auslegung sowohl für Mess- als auch für Schutzzwecke einsetzbar ist.
- Der modulare Aufbau dieser Geräteserie lässt eine große Anzahl von Variationen innerhalb der einzelnen Baugrößen zu (z.B. zwei Kerne in einem Gerät), Details zu den Baugrößen finden Sie auf der nächsten Seite.
- Nennspannung: 0,72/3/- kV oder 1,2/6/- kV; bei entsprechender Isolation kann der Stromwandler auch oberhalb der 0,72 kV bzw. 1,2 kV eingesetzt werden.
- Primärstrombereiche: 30 A ... 5000 A
- Sekundärströme: 1 A, 2 A oder 5 A
- Nennleistungen: 1 VA ... 30 VA
- Genauigkeitsklassen Messwandler 0,2S; 0,2; 0,5S; 0,5; 1; 3
- Überstrombegrenzungsfaktor für Messkerne: FS5 oder FS10
- Genauigkeitsklassen Schutzstromwandler 5P / 10P / PX
- Genauigkeits-Grenzfaktor für Schutzkerne: 5, 10, 15, 20, 30

Abmessungen:

Primärleiterdurchmesser:	max. 200 mm
Baubreite:	100 - 300 mm
Bautiefe:	60 - 300 mm

Details zu den Abmessungen finden Sie auf der nächsten Seite.

Technische Daten:

Therm. Bem.-Dauerstrom I_{cth} :	$1,0 \times I_{pr}$ oder $1,2 \times I_{pr}$ andere Werte auf Anfrage
Therm. Bem.-Kurzzeitstrom I_{th} :	Min. $100 \times I_{pr} / 1 \text{ Sek.}$, max. 100kA andere Werte auf Anfrage
Dynamischer Bem.-Stoßstrom I_{dyn} :	$2,5 \times I_{th}$
Max. Betriebsspannung U_m :	0,72 kV oder 1,2 kV
Isolationsprüfspannung:	3 kV, U_{eff} , 50 Hz, 1 Min. oder 6 kV, U_{eff} , 50 Hz, 1 Min.
Nenn-Frequenz:	50 Hz oder 60 Hz, andere Werte auf Anfrage
Isolierstoffklasse:	E
Angewandte technische Normen:	DIN EN 61869, Teil 1 + 2

Weitere Informationen:

- In Polyurethan vollvergossener Stromwandler
- Die Stromwandler des Typs CTR sind für den Einbau in neuen Niederspannungsschaltanlagen vorgesehen. Darüber hinaus gibt es Anwender, welche diesen Stromwandler bei entsprechender Isolation des Primärleiters auch in Mittelspannungsschaltanlagen einsetzen. Weitere Einsatzgebiete sind Windenergieanlagen, Anlagen zur Energieerzeugung auf Schiffen, Energieverteilungsanlagen,...
- Der Stromwandler wird in Standardausführung mit einem runden Kernfenster gefertigt, kann aber optional auch mit eckigem Kernfenster für Schienenmontage geliefert werden.
- Die Sekundäranschlüsse werden werkseitig mit M5-Schrauben bestückt. Als Berührungsschutz dient eine Klarsicht-Abdeckkappe.
- Schutzart: Gehäuse: IP54, Klemmenabdeckung: IP20
- Arbeitstemperaturbereich: $-5^\circ\text{C} < T < +50^\circ\text{C}$
- Lagertemperaturbereich: $-25^\circ\text{C} < T < +70^\circ\text{C}$
- Wandlerbefestigung mittels am Gießharzkörper angebrachten Fußleisten (opt.: stirnseitige Gewindebuchsen)
- Verpackungseinheit: 1 Stk.
- Zolltarifnummer: 85043129

Maßbilder:

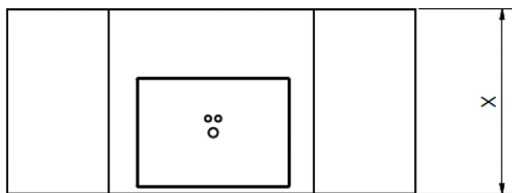
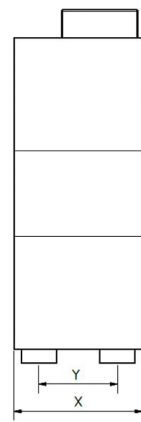
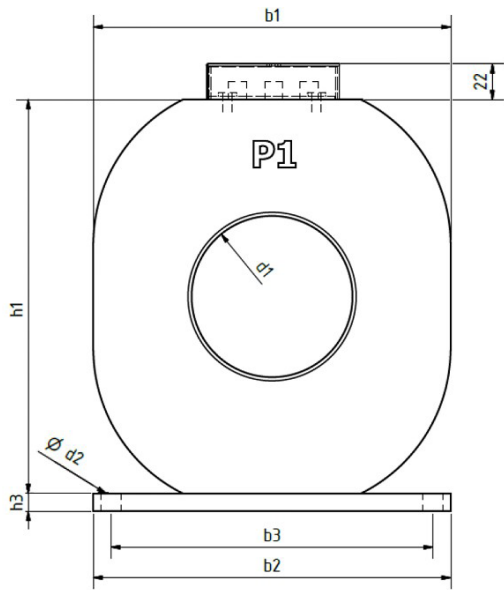

X*	Y*
60	30 ¹⁾
90	60 ¹⁾
120	90 ¹⁾
150	120
200	170
250	220
300	270

* Bautiefe (Maß x + y) abhängig von Art und Anzahl der installierten Messsysteme.

1) Abweichende Maße bei CTR 100

Bei x = 60 mm: y = 75 mm

Bei x = 90 mm: y = 105 mm

Bei x = 120 mm: y = 135 mm

Bestimmung der Wandlerbezeichnung:

Beispiel: **CTR 200 / 130**

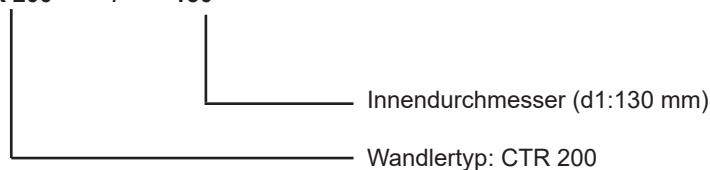

Typ	b1	b2	b3	max. d1	d2	h1	h2	h3	Baugröße
CTR 100	100	100	80	60	9	110	55	5	max. 120 mm
CTR 150	150	150	130	110	9	165	82.5	10	max. 150 mm
CTR 170	170	170	150	110	11	185	97.5	10	max. 150 mm
CTR 200	200	200	180	140	11	220	110	10	max. 200 mm
CTR 250	250	250	230	150	11	270	135	10	max. 200 mm
CTR 300	300	300	280	210	11	330	165	10	max. 250 mm

CTO

Kabelumbau-Stromwandler im Vollverguss für Innenraumanwendungen 0,72 kV / 1,2 kV



Merkmale / Nutzen

- Kabelumbau-Stromwandler je nach Auslegung geeignet sowohl für Mess- als auch für Schutzzwecke
- Der modulare Aufbau dieser Geräteserie lässt eine große Anzahl von Variationen innerhalb der einzelnen Baugrößen zu (Details zu den Baugrößen finden Sie auf der nächsten Seite).
- Nennspannung: 0,72/3/- kV oder 1,2/6/- kV; bei entsprechender Isolation kann der Stromwandler auch oberhalb der 0,72 kV bzw. 1,2 kV eingesetzt werden.
- Primärstrombereiche: 50 A ... 5000 A
- Sekundärströme: 1 A, 2 A oder 5 A
- Nennleistungen: 2,5 VA ... 30 VA
- Genauigkeitsklassen Messwandler 0,2S; 0,2; 0,5S; 0,5; 1; 3
- Überstrombegrenzungsfaktor für Messkerne: FS5 oder FS10
- Genauigkeitsklassen Schutzstromwandler 5P / 10P / PX
- Genauigkeits-Grenzfaktor für Schutzkerne: 5, 10, 15, 20, 30

Abmessungen:

Primärleiterdurchmesser:	max. 200 mm
Baubreite:	150 - 300 mm
Bautiefe:	90 - 300 mm

Details zu den Abmessungen finden Sie auf der nächsten Seite.

Technische Daten:

Therm. Bem.-Dauerstrom I_{cth} :	1,0 x I_{pr} oder 1,2 x I_{pr} , andere Werte auf Anfrage
Therm. Bem.-Kurzzeitstrom I_{th} :	Min. 100 x I_{pr} / 1 Sek., andere Werte auf Anfrage
Dynamischer Bem.-Stoßstrom I_{dyn} :	2,5 x I_{th}
Max. Betriebsspannung U_m :	0,72 kV oder 1,2 kV
Isolationsprüfspannung:	3 kV, U_{eff} , 50 Hz, 1 Min. oder 6 kV, U_{eff} , 50 Hz, 1 Min.
Nenn-Frequenz:	50 Hz oder 60 Hz, andere Werte auf Anfrage
Isolierstoffklasse:	E
Angewandte technische Normen:	DIN EN 61869, Teil 1 + 2

Weitere Informationen:

- In Polyurethan vollvergossener Kabelumbau-Stromwandler
- Die Stromwandler des Typs CTO sind für den nachträglichen Einbau in bestehenden Niederspannungsschaltanlagen vorgesehen. Darüber hinaus gibt es Anwender, welche diesen Stromwandler bei entsprechender Isolation des Primärleiters auch in Mittelspannungsschaltanlagen einsetzen. Weitere Einsatzgebiete sind Windenergieanlagen, Anlagen zur Energieerzeugung auf Schiffen, Energieverteilungsanlagen,...
- Die beiden Stromwandler-Hälften werden über vier Schrauben mit Druckfedern oder Federspangen an den Seiten zusammengehalten, was einen gleichmäßigen Anpressdruck beider Hälften gewährleistet.
- Die Sekundäranschlüsse werden werkseitig mit M5-Schrauben bestückt. Als Berührungsschutz dient eine Klarsicht-Abdeckkappe.
- Schutzart: Gehäuse: IP54, Klemmenabdeckung: IP20
- Arbeitstemperaturbereich: $-5^{\circ}\text{C} < T < +40^{\circ}\text{C}$
- Lagertemperaturbereich: $-25^{\circ}\text{C} < T < +70^{\circ}\text{C}$
- Wandlerbefestigung mittels am Gießharzkörper angebrachten Fußleisten
- Verpackungseinheit: 1 Stk.
- Zolltarifnummer: 85043129

Maßbilder:

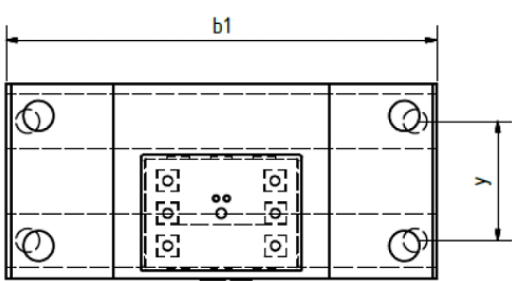
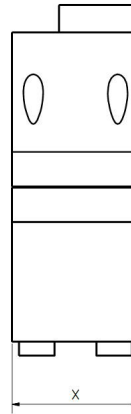
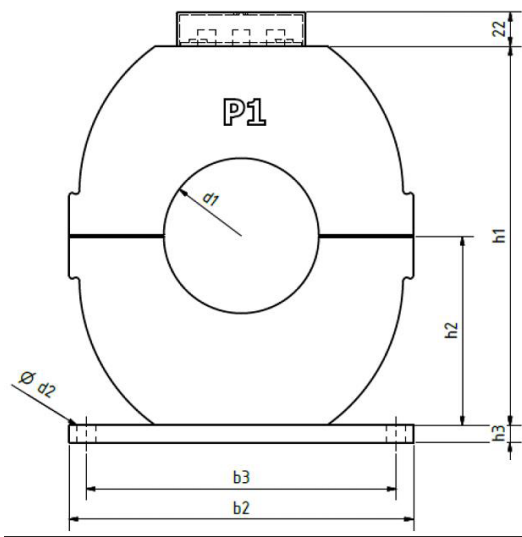

X*	Y*
90	60
120	90
150	120
200	170
250	220
300	170

* Bautiefe (Maß x + y) abhängig von Art und Anzahl der installierten Messsysteme.

Bestimmung der Wandlerbezeichnung:

Beispiel: **CTO 200 / 130**

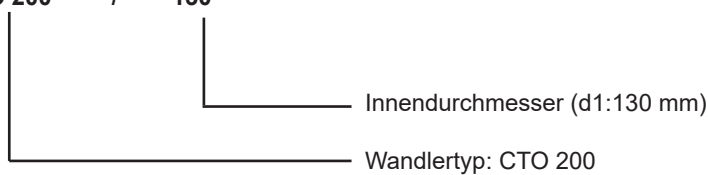

Typ	b1	b2	b3	max. d1	d2	h1	h2	h3	Baugröße
CTO 150	150	150	120	110	9	170	85	10	max. 120 mm
CTO 170	170	170	150	110	11	185	92.5	10	max. 120 mm
CTO 200	200	200	180	140	11	200	100	10	max. 300 mm
CTO 250	250	250	230	160	11	290	145	10	max. 300 mm
CTO 300	300	300	280	210	11	340	170	10	max. 300 mm

- Stromwandler Industrie
- Stromwandler Verrechnung
- Wandler Zubehör
- Mittelspannungs-Wandler

- Stromschienen-Isolatoren/-Halter
- Nebenwiderstände
- Spannungswandler
- Allstromsensoren
- Messumformer
- Energiezähler mit oder ohne MID-Zulassung
- Energiezähler-Zubehör
- Schaltschrank-Heizungen, Filter- / Dachlüfter und Regelgeräte



www.mbs-ag.com

MBS AG

Eisbachstraße 51 74429 Sulzbach-Laufen Germany
Telefon: +49 7976 9851-0 Telefax: +49 7976 9851-90
info@mbs-ag.com www.mbs-ag.com

