



# Multipole connectors

---

20

21

---



## THE TRADITION OF INNOVATION SINCE 1945

ILME designs and manufactures complete solutions for industrial connections.

Headquartered in Milan and with subsidiaries in the key countries driving the progress of automation, ILME is an industry leader in the main world markets.

People are vital to success and growth at ILME, sharing a passion for innovation, utmost responsibility and participation.

The Company is committed to developing technology in the areas that most impact the future of the industries it serves: original solutions and safe wiring, research on the most suitable materials, rapid turnaround and readily available services while striving for energy saving and environmental safeguard.

## COMMITMENT TO INDUSTRY

Technological innovation is the main pillar of ILME competitiveness.

In the electrical connection sector of industrial automation, characterized by the need for top performance and reliability, ILME is an acknowledged leader with its own patents, and a global benchmark supplier of major companies worldwide.

ILME offers a fully integrated range of high-quality products and services for every type of connection to suit any application requirements.



AUTOMATION



RAILWAY



ENERGY



MARINE



FOOD  
& BEVERAGE



AGRONOMY



OUTDOOR



TRANSPORT



LIGHT  
& SOUND



PLASTICS



CHEMICAL



AIRPORT

# IMPORTANT NOTES

- 1 ILME designs and manufactures complete solutions for Heavy Duty electrical power connections.  
The connector (although offered to the user as a variety of elements, usually inserts and enclosures, to allow the selection of the ideal combination) has been **designed as a complete connector** and tested to be compliant with the essential safety requirements of the EU Low Voltage Directive 2014/35/EU and in particular the EN 61984 standard. The design of this “whole” system guarantees that every allowed combination of inserts, enclosures and accessories cannot result as improper.

---

- 2 The products in this catalogue alone cannot guarantee the best functionality upon installation, as this depends also on their correct **“putting into service”** which must be performed in compliance with the applicable system safety standards and according to the “rule of the art”. Therefore the effectiveness of the installation of the connector depends on the choices of the end user who must also take into account the following safety requirements.

---

- 3 Connectors must **not be connected or disconnected when live or under load.**

---

- 4 After wiring the inserts it is necessary to **verify the continuity of the protective earth connections.**

---

- 5 The **correct coupling of the inserts** is guaranteed only if they are installed (with the four fixing screws supplied \*) inside the corresponding enclosures or onto compatible accessories in this catalogue. ILME S.p.A. is not responsible for any different application.

---

- 6 Wiring of **screw-type terminal connections** must be carried out applying the correct tightening torque in order to avoid false contacts or damage to the conductor, the screw or the terminal.

---

- 7 **Crimping tools** and **crimp contacts** used should preferably be supplied by the same manufacturer to avoid difficulties with the insertion and retention or damaging of the contacts themselves.

---

- 8 Correct wiring of **spring-clamp connection inserts** is guaranteed only when the correct screwdriver indicated in the specific catalogue, or possibly on the insert, is used \*\*.

---

- 9 Avoid forcing the contacts during **connection and disconnection**. Connectors must be coupled and uncoupled in the axial direction with respect to the contacts, without bending and pulling the attached conductor bundles or cables.

---

- 10 Installation of two **inserts side by side**, in enclosures with two bays, must respect the polarity drawing marked on the insert (or the contact side view, as shown in this catalogue) to avoid inverted coupling.

---

- 11 Installation of two or more identical **connectors side by side** is recommended only with the use of **coding pins** in order to avoid mismatched couplings.

---

- 12 In order to keep the declared **degree of protection** (IP code according to EN 60529, or Enclosure Type Rating according to ANSI/UL 50E), enclosures must be completed with cable glands and/or other accessories with at least an equal degree of protection.

---

- 13 Moreover, the declared **degree of protection** (IP code according to EN 60529, or Enclosure Type Rating according to ANSI/UL 50E) is guaranteed when the enclosures, complete with inserts, are coupled and locked with their locking levers (or devices).

---

- 14 Connector inserts and their enclosures are generally compatible with similar/equivalent products from other manufacturers, according to the last samples tested. Full compatibility cannot be guaranteed in the event of technical changes made by other manufacturers. In particular, maximum performance of IP68 enclosures (CG-MG, CGK-MGK Series) cannot be guaranteed when coupled with other manufacturers' products.

---

- 15 **Spare parts** are supplied in minimum quantities only with the purpose to replace damaged parts. To avoid invalidation of warranty, products should be modified or repaired only by ILME: the integrity of their functionality - e.g. their degree of protection - can no longer be guaranteed if products are modified/repared by end-users. In any case, the liability for correct choice, assembly and use is totally at charge of the installer and the end-user.

---

- 16 ILME S.p.A. takes no responsibility in verifying whether the components herein contained comply with any specific regulations of fields of application.

---

- 17 ILME cannot be held responsible for individual components in **uses other than those described in this catalogue.**  
ILME cannot be held responsible for **incorrect connector selection** in relation to the environmental conditions of the application (e.g.: influence of ambient temperature, moisture, environmental pollution, etc.).

---

\* Except one fixing screw for size “21.21” inserts, two fixing screws for size “32.13” inserts.

\*\* Except for **SQUICH®** inserts (with spring-clamp terminals with actuator button) that do not require any tool to operate the terminal.



## CE MARKING

As from 1<sup>st</sup> January 1997, in order to make available electrical products on the European market, the manufacturer must ensure that these bear the relevant **CE marking**, in line with the Low Voltage Directive 73/23/EEC\* (implemented in Italy as L. D. 18-10-1977 no. 791) and its modification 93/68/EEC\* (implemented in Italy as L.D. 25-11-1996 no. 626/96, published in the supplement to the Gazzetta Ufficiale of 14-12-1996).

The CE marking must be visible on the product or, if this is not possible, on the packaging, the instructions for use or on the warranty certificate. It acts as a declaration by the manufacturer that the product complies with all relevant EU directives regarding its field of application.

### **ILME products bear the CE marking on the actual product or its packaging.**

Almost all ILME products fall within the scope of the Low Voltage Directive. An EU declaration of conformity is required in order to be able to apply the CE marking. This declaration, to which the market is not directly entitled, must be made available to the controlling authorities (in Italy, the Ministry of Economic Development) at all times. In it, the manufacturer declares the technical safety standard(s) followed in the design and manufacture of the product. These standards must be, in decreasing order of preference:

- a European standard (EN prefix)
- a European harmonisation document (HD prefix)
- an international IEC standard
- a national standard
- in the absence of reference standards, the manufacturer's internal specifications guaranteeing compliance with the basic safety requirements of the directive.

Conformity with harmonised technical standards (i.e. ratified by CENELEC) also constitutes presumption of conformity with the basic safety requirements of the directives.

The CE marking of ILME products results from the declaration of conformity of the product to harmonised standards or international IEC standards.

Through the CE marking, ILME declares full compliance, not merely with the directive's basic safety requirements, but also with those international or national standards on which voluntary safety certification markings are based (e.g. IMQ and VDE). In this way, ILME intends to give the CE marking the value of self-certification in terms of safety, given the loss in legal value of voluntary certifications issued by third parties, ratified by directive 93/68/EEC\*.

Notwithstanding the above, practically all ILME products still bear voluntary conformity markings.

The above mentioned EU declaration of conformity becomes null and void when the assembly of products includes one or more components not manufactured by ILME and without CE marking.

**⚠ The information contained in this catalogue is not binding and may be changed without notice.**

\* **Note:** The subsequent legal reference for the Low Voltage Directive was 2006/95/EC, as consolidation of the original Directive 73/23/EEC + Directive 93/68/EEC. On 29<sup>th</sup> March 2014, the Official Journal of the European Union published the new Low Voltage directive 2014/35/EU dd. 26<sup>th</sup> February 2014, a recast version of directive 2006/95/EC, which is in force since 20<sup>th</sup> April 2016.



UNI EN ISO 9001: 2015  
Design, manufacture and distribution  
of industrial electrical equipment (IAF 19)  
Certificate No. 50 100 11133

Visit [ilme.com](https://ilme.com) website to discover all the main features:



**Technical datasheets**  
to get all the information about our products.



**Application pages**  
to focus on installation locations, field requirements and technical details.



**Download Area**  
to find all the useful files in a click.

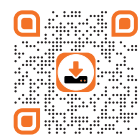





# 2021 PRODUCTS

## Inserts

14

### CXC SERIES - CRIMP COMBINED CONNECTOR 80 A / 16 A



CXCF /M 4/2  
Technical features

14  
15 - 17

### CXC SERIES - CRIMP COMBINED CONNECTOR 80 A / 16 A



CXCF /M 4/8  
Technical features

18  
19 - 21

### **FOCUS ON CX7 CRIMP CONTACTS SERIES** **CURRENT-CARRYING CAPACITY UP TO 80 A**

22 - 23

### CX SERIES - POWER CRIMP CONNECTOR 100 A



CXF /M 8/0  
Technical features

24  
25 - 27

### **RSH-SQUICH® CONNECTOR SERIES** **HNM VERSION**

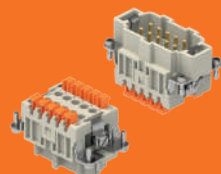

RSHF /M 06/10/16/24  
Technical features

28  
29 - 33

### **RDSH-SQUICH® CONNECTOR SERIES** **HNM VERSION**

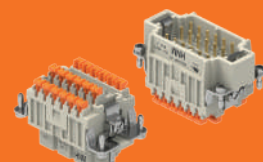

RDSHF /M 09/18/27/42  
Technical features

34  
35 - 39

## MIXO modular units

40

### MIXO SERIES

General Overview

40

### THE COMPLETE RANGE

42

### TECHNICAL CHARACTERISTICS

43

### MIXO NOVELTIES ADVANTAGES

44



#### MIXO RJ45

##### MALE PATCH CORD UNIVERSAL ADAPTER

CX 01 J8UM

46

Technical features

47 - 49

#### MIXO DATA WITH ADDITIONAL SHIELD BONDING CONTACTS



#### MIXO MEGABIT

CX 08 D5GF /D5GM

CX 08 D5GF2 /D5GM2

50 - 51

Technical features

52 - 59

#### HNM VERSION

RX 08 D5GF /D5GM

RX 08 D5GF2 /D5GM2

Technical features

54 - 59

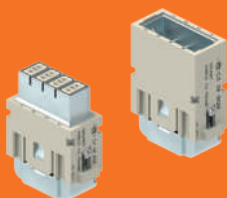

#### MIXO GIGABIT

CX 08 I6GF /I6GM

50 - 51

Technical features

60 - 65

#### HNM VERSION

RX 08 I6GF /I6GM

Technical features

62 - 65

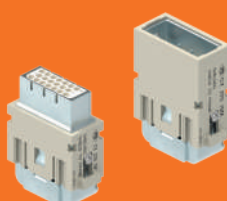

#### MIXO SHIELDED

CX 20S IGF /IGM

50 - 51

Technical features

66 - 71

#### HNM VERSION

RX 20S IGF /IGM

Technical features

68 - 71



### MIXO PNEUMATIC METAL

CX 03 MP

Technical features

72

73 - 75



### METAL PNEUMATIC CONTACTS

CX 3.0/4.0/6.0 MP ..

74 - 75

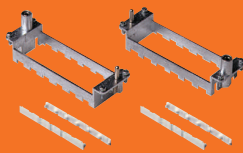

### MIXO FRAMES

HNM VERSION

76

77

## Contacts

78



### FINGERPROOF

70 A MALE CRIMP CONTACTS

CX7MA 6.0/10/16/25 P

Technical features

78

79 - 81

## PCB Adapters

82

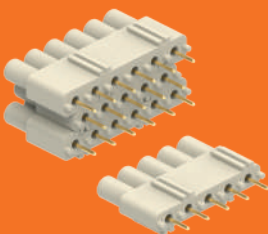

### PCB INTERFACE ADAPTER

FOR MIXO CX 17 DF /DM

CIF X17 2.4 (complete set)

CIF 5 2.4 (5P adapter)

Technical features

82

82

83 - 85

## Data Connectors

86



### ANGLED RJ45 COUPLER (F/F)

IN BULKHEAD ANGLED HOUSING

CJZA 8 IA4, CJZAX 8 IA4, CJZAXX 8 IA4

Technical features

86

87 - 89

## Enclosures

90



**MKA IF**  
**M32 BULKHEAD MOUNT HOUSING**  
**WITH FLANGE GASKET, SIZE "21.21"**  
MKA IFC, MKAX IFC, MKAXX IFC  
Technical features

90  
91 - 93



**IP68 VERSION ANGLED HOUSING**  
**FOR 2 INSERTS, SIZE "21.21"**  
MGK 2AP25  
Technical features

94  
95 - 99



**T-TYPE HYGIENIC**  
**WITH METAL DETECTABLE LEVERS**  
T-TYPE/H & T-TYPE/C  
Technical features

100  
101



## Accessories

102



### PLANARITY GASKETS FOR T-TYPE SURFACE MOUNTING HOUSING

CR 06/10/16/24 GTPC

Technical features

102

103 - 105



### FLANGE GASKET FOR MKAS IVG20 REVERSE MOUNTING

CR 03 GKIVGR

Technical features

106

107 - 109



### COVER "104.62" WITH LEVER AND GASKET

CHC 48 LG

Technical features

110

111 - 113

## Part numbers index

116

---

## CXC SERIES - CRIMP COMBINED CONNECTOR

### CXCF /M 4/2

---

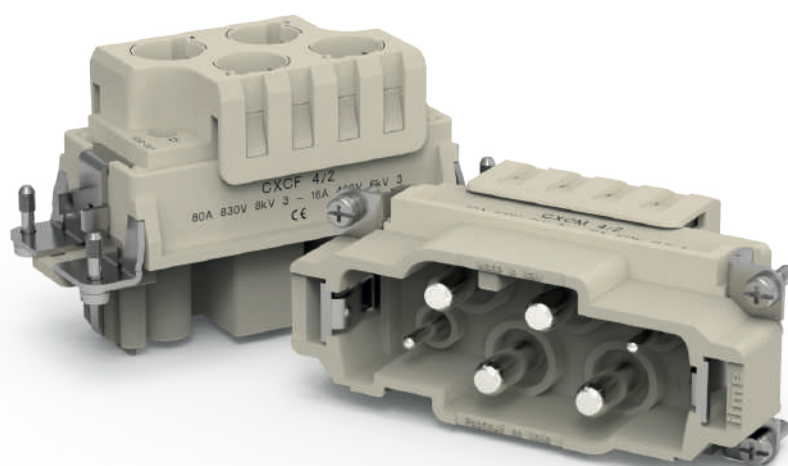

CXC Combined power/auxiliaries crimp connector Series

4 poles + ⊕: 80 A 830 V 8 kV 3

2 poles + ⊕: 16 A 400 V 6 kV 3



Find more information on our products at [www.ilme.com](http://www.ilme.com)

## TECHNICAL FEATURES

### CXCF /M 4/2

For use with up to 4 removable crimp contacts series **CX7** (power side) and up to 2 removable crimp contacts series **CC** (auxiliary/signal side).

For use with working current on power contacts up to 80 A (see focus on page 22) and on auxiliary contacts up to 16 A.

Interchangeable and intermateable with the screw-type version **CXF/M 4/0** and **CXF/M 4/2** (see CN.19 catalogue pages 200-201), same voltage and current ratings.

NOTE – Where screw-type version of connector exists, e.g. **CX 4/2**, **CX 4/8**, to identify the crimp variant a C is being added in the code of the “crimp” version. Crimp versions allow on power poles use of conductors with cross-sectional area up to 25 mm<sup>2</sup> / 4-3 AWG.

Inserts made by UL 94V-0 glass reinforced polycarbonate, EN 45545-2:2015 compliant.

By employing crimp contacts, it covers all applications demanding the highest vibration resistance (e.g. railway rolling stock).

**CX7** contacts available in 4 sizes (6.0 /10 /16 /25) to match equally sized conductors (mm<sup>2</sup>).

**Removal tool for CX7 contacts:**

**CX7ES** (improved shape of existing C7ES to better fit application in these inserts).

**Removal tool for CC contacts:**

**CQES.**

**Max diameter of wire sheathings:**

- 10 mm in the 4P power core section
- 4.5 mm in the 2P auxiliaries

cURus, CSA, CQC, DNV-GL, BV, EAC pending.

**RoHS:** compliant without exemptions.

NOTE - The turned crimp contacts series **CX7** and **CC** are **RoHS** compliant with exemption 6(c).

crimp variant  
intermateable  
with corresponding  
screw-type version  
CX 4/2, CX 4/0, to  
cover all applications  
demanding the highest  
vibration resistance

 crimp contacts CX7  
and CC series are  
separately available

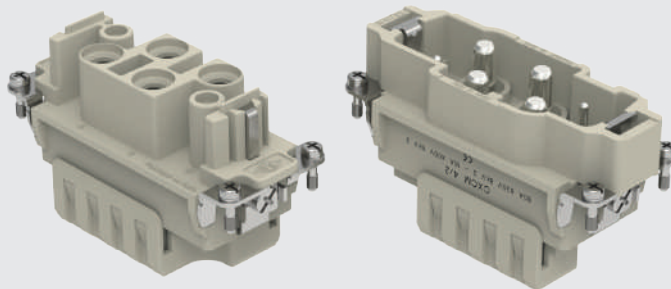

# CXCF /M 4/2 4 poles (80 A - 830 V) + 2 poles (16 A - 400 V) + ⊕

enclosures:  
size "77.27"

page:

C-TYPE IP65 or IP66/IP69	402 - 411
C7 IP67, two levers	439 - 440
V-TYPE IP65 or IP66/IP69, single lever	454 - 458
BIG hoods	470 - 471
T-TYPE IP65 insulating	484 - 485
T-TYPE / W IP66/IP69 insulating	491
HYGIENIC T-TYPE / H IP66/IP69	503
HYGIENIC T-TYPE / C IP66/IP69, -50 °C	508
W-TYPE for aggressive environments	523
E-Xtreme® corrosion proof	534 - 535, 544, 554 - 555
EMC	580
Central lever	609 - 611
LS-TYPE	622 - 623
IP68	640 - 643

panel supports:

COB	652 - 653
-----	-----------

enclosures:

bulkhead mounting housings, high construction housings or high construction hoods

refer to CN.19 pages

inserts, crimp connections

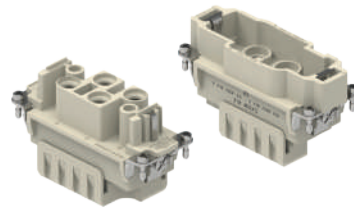

**FROM SEPTEMBER 2021**

80 A crimp contacts  
silver plated



description

part No.

part No.

without contacts (to be ordered separately)  
female inserts for female contacts  
male inserts for male contacts

CXCF 4/2  
CXCM 4/2

80 A female crimp contacts  
6 mm<sup>2</sup> AWG 10  
10 mm<sup>2</sup> AWG 8 - 7  
16 mm<sup>2</sup> AWG 6 - 5  
25 mm<sup>2</sup> AWG 4 - 3

CX7FA 6.0  
CX7FA 10  
CX7FA 16  
CX7FA 25

80 A male crimp contacts  
6 mm<sup>2</sup> AWG 10  
10 mm<sup>2</sup> AWG 8 - 7  
16 mm<sup>2</sup> AWG 6 - 5  
25 mm<sup>2</sup> AWG 4 - 3

CX7MA 6.0  
CX7MA 10  
CX7MA 16  
CX7MA 25

silver plated

- characteristics according to EN/IEC 61984 ratings:

**80 A 830 V 8 kV 3**  
**16 A 400 V 6 kV 3**

- cURus, CSA, CQC, DNV-GL, BV, EAC pending
- rated voltage according to UL/CSA: 600 V
- insulation resistance: ≥ 10 GΩ
- Lower and Upper Limiting Temperatures (LLT ... ULT):  
-40 °C ... +125 °C
- made by UL 94V-0 glass reinforced polycarbonate,  
EN 45545-2:2015 compliant
- mechanical life: ≥ 500 cycles
- contact resistance: ≤ 0,3 mΩ (4 power poles)  
≤ 1 mΩ (2 auxiliary poles)
- **it is recommended to crimp the contacts with crimping tools homologated by ILME** (please see the crimping tool section 70 A contacts CX7F and CX7M series and 16 A contacts CCF, CCM series, on pages 708 - 741 of CN.19 catalogue).
- for max. current load see the connector inserts derating diagrams **under construction**.

CXC 4/2

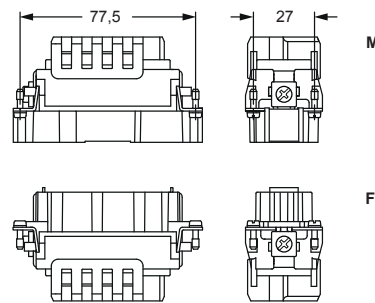

contacts side (front view)

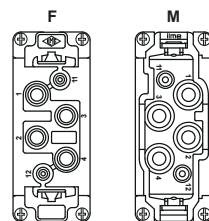

CX7F and CX7M

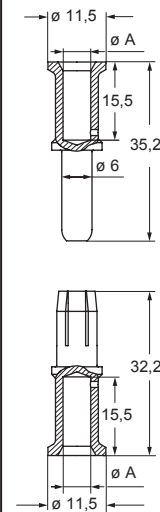

**CX7F and CX7M contacts**

conductor section (mm <sup>2</sup> )	conductor slot $\varnothing$ A (mm)	conductor stripping length (mm)
6	3,5	15
10	4,3	15
16	5,5	15
25	7,0	15

# CXCF /M 4/2 4 poles (80 A - 830 V) + 2 poles (16 A - 400 V) + ⊕

16 A crimp contacts  
silver plated



removal tools



description	part No.	part No.
<p>16 A female crimp contacts</p> <p>0,14-0,37 mm<sup>2</sup> AWG 26-22 one groove <b>CCFA 0.3</b></p> <p>0,5 mm<sup>2</sup> AWG 20 with no grooves <b>CCFA 0.5</b></p> <p>0,75 mm<sup>2</sup> AWG 18 one groove (back side) <b>CCFA 0.7</b></p> <p>1 mm<sup>2</sup> AWG 18 one groove <b>CCFA 1.0</b></p> <p>1,5 mm<sup>2</sup> AWG 16 two grooves <b>CCFA 1.5</b></p> <p>2,5 mm<sup>2</sup> AWG 14 three grooves <b>CCFA 2.5</b></p> <p>3 mm<sup>2</sup> AWG 12 one wide groove <b>CCFA 3.0</b></p> <p>4 mm<sup>2</sup> AWG 12 with no grooves <b>CCFA 4.0</b></p>	silver plated	
<p>16 A male crimp contacts</p> <p>0,14-0,37 mm<sup>2</sup> AWG 26-22 one groove <b>CCMA 0.3</b></p> <p>0,5 mm<sup>2</sup> AWG 20 with no grooves <b>CCMA 0.5</b></p> <p>0,75 mm<sup>2</sup> AWG 18 one groove (back side) <b>CCMA 0.7</b></p> <p>1 mm<sup>2</sup> AWG 18 one groove <b>CCMA 1.0</b></p> <p>1,5 mm<sup>2</sup> AWG 16 two grooves <b>CCMA 1.5</b></p> <p>2,5 mm<sup>2</sup> AWG 14 three grooves <b>CCMA 2.5</b></p> <p>3 mm<sup>2</sup> AWG 12 one wide groove <b>CCMA 3.0</b></p> <p>4 mm<sup>2</sup> AWG 12 with no grooves <b>CCMA 4.0</b></p>		
<p>removal tools for <b>CX7</b> series contacts</p> <p>for <b>CC</b> series contacts</p>		<p><b>CX7ES</b></p> <p><b>CQES</b></p>

**CCF and CCM**

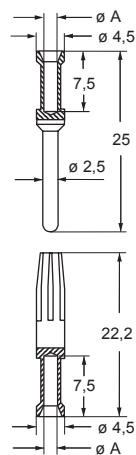

**CCF and CCM contacts**

conductor section (mm <sup>2</sup> )	conductor slot $\varnothing A$ (mm)	conductors stripping length (mm)
0,14-0,37	0,9	7,5
0,5	1,1	7,5
0,75	1,3	7,5
1,0	1,45	7,5
1,5	1,8	7,5
2,5	2,2	7,5
3	2,55	7,5
4	2,85	7,5

---

## CXC SERIES - CRIMP COMBINED CONNECTOR

### CXCF /M 4/8

---

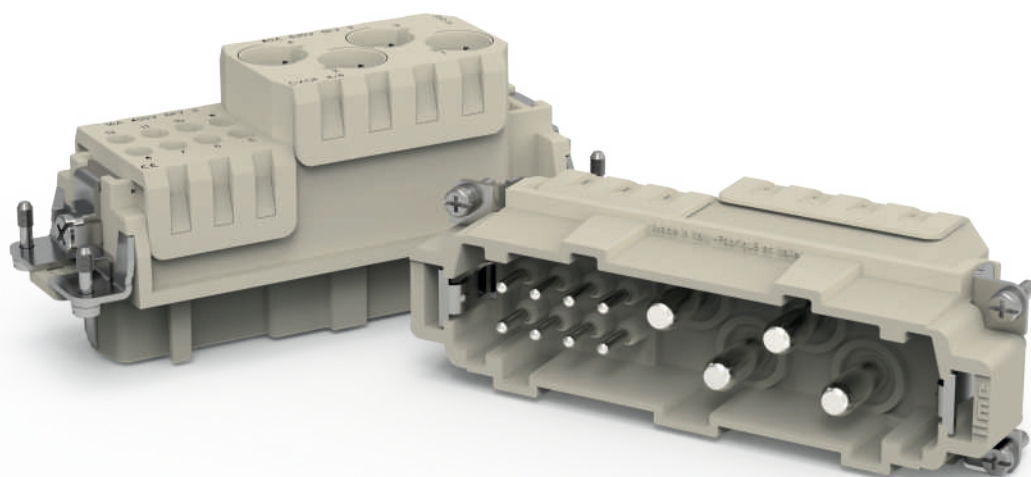

CXC Combined power/auxiliaries crimp connector Series

4 poles + ⊕: 80 A 400 V 6 kV 3

8 poles + ⊕: 16 A 230/400 V 4 kV 3



Find more information on our products at [www.ilme.com](http://www.ilme.com)

## TECHNICAL FEATURES

### CXCF /M 4/8

For use with up to 4 removable crimp contacts series **CX7** (power side) and up to 8 removable crimp contacts series **CC** (auxiliary/signal side).

For use with working current on power contacts up to 80 A (see focus on page 22) and on auxiliary contacts up to 16 A.

Interchangeable and intermateable with the screw-type version **CXF /M 4/8** (see CN.19 catalogue page 204), same voltage and current ratings. Inserts made by UL 94V-0 glass reinforced polycarbonate, EN 45545-2:2015 compliant.

NOTE – Where the screw-type version of a connector exists, e.g. **CX 4/2**, **CX 4/8**, to identify the crimp variant a C is being added in the code of the “crimp” version. Crimp versions allow on power poles use of conductors with cross-sectional area up to 25 mm<sup>2</sup> / 4-3 AWG.

By employing crimp contacts, it covers all applications demanding the highest vibration resistance (e.g. railway rolling stock, ships).

**CX7** contacts available in 4 sizes (6.0 /10 /16 /25) to match equally sized conductors (mm<sup>2</sup>).

**Removal tool for CX7 contacts:**

**CX7ES** (improved shape of existing C7ES to better fit application in these inserts).

**Removal tool for CC contacts:**

**CQES**

**Max diameter of wire sheathings:**

- 10 mm in the 4P power core section
- 4.5 mm in the 8P auxiliaries

cURus, CSA, CQC, DNV-GL, BV, EAC pending.

**RoHS:** compliant without exemptions

NOTE - The turned crimp contacts series **CX7** and **CC** are **RoHS** compliant with exemption 6(c).

crimp variant  
of CXF /M 4/8,  
to cover all  
applications  
demanding the  
highest vibration  
resistance

☞ crimp contacts CX7  
and CC series are  
separately available

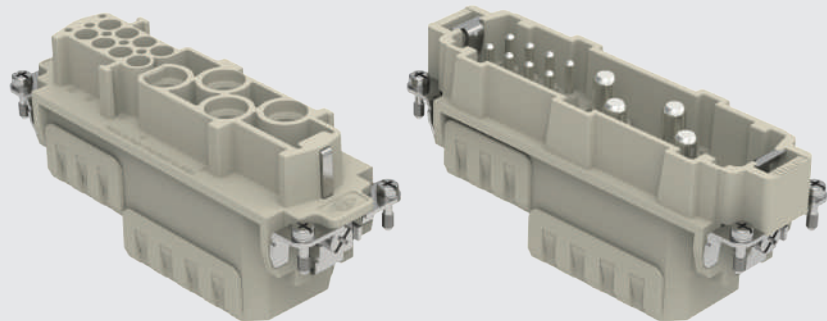

# CXCF /M 4/8 4 poles (80 A - 400 V) + 8 poles (16 A - 230/400 V) + ⊕

enclosures:  
size "104.27"

page:

C-TYPE IP65 or IP66/IP69	412 - 423
C7 IP67, two levers	441 - 442
V-TYPE IP65 or IP66/IP69, single lever	459 - 463
BIG hoods	472 - 473
T-TYPE IP65 insulating	486 - 487
T-TYPE / W IP66/IP69 insulating	492
HYGIENIC T-TYPE / H IP66/IP69	504
HYGIENIC T-TYPE / C IP66/IP69, -50 °C	509
W-TYPE for aggressive environments	524
E-Xtreme® corrosion proof	536 - 537, 545, 556 - 557
EMC	581
Central lever	612 - 614
LS-TYPE	624 - 625
IP68	644 - 647

panel supports:

COB	652 - 653
-----	-----------

enclosures:  
bulkhead mounting housings, high construction housings  
or high construction hoods

refer to CN.19 pages

inserts, crimp connections

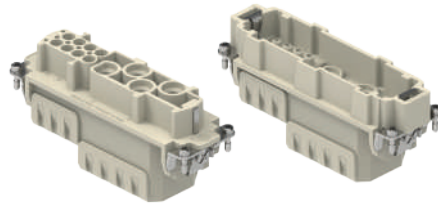

**FROM SEPTEMBER 2021**

80 A crimp contacts  
silver plated



description

part No.

part No.

without contacts (to be ordered separately)  
female inserts for female contacts  
male inserts for male contacts

CXCF 4/8  
CXCM 4/8

80 A female crimp contacts  
6 mm<sup>2</sup> AWG 10  
10 mm<sup>2</sup> AWG 8 - 7  
16 mm<sup>2</sup> AWG 6 - 5  
25 mm<sup>2</sup> AWG 4 - 3

CX7FA 6.0  
CX7FA 10  
CX7FA 16  
CX7FA 25

80 A male crimp contacts  
6 mm<sup>2</sup> AWG 10  
10 mm<sup>2</sup> AWG 8 - 7  
16 mm<sup>2</sup> AWG 6 - 5  
25 mm<sup>2</sup> AWG 4 - 3

CX7MA 6.0  
CX7MA 10  
CX7MA 16  
CX7MA 25

silver plated

- characteristics according to EN/IEC 61984 ratings:

- 80 A 400 V 6 kV 3**
- 16 A 230/400 V 4 kV 3**
- cURus, CSA, CQC, DNV-GL, BV, EAC pending
- rated voltage according to UL/CSA: 600 V
- insulation resistance: ≥ 10 GΩ
- ambient temperature limit: -40 °C ... +125 °C
- made by UL 94V-0 glass reinforced polycarbonate, EN 45545-2:2015 compliant
- mechanical life: ≥ 500 cycles
- contact resistance: ≤ 0,3 mΩ (4 power poles)  
≤ 1 mΩ (8 auxiliary poles)
- **it is recommended to crimp the contacts with crimping tools homologated by ILME** (please see the crimping tool section 70 A contacts CX7F and CX7M series and 16 A contacts CCF, CCM series, on pages 708 - 741 of CN.19 catalogue).
- for max. current load see the connector inserts derating diagrams **under construction**.

CXC 4/8

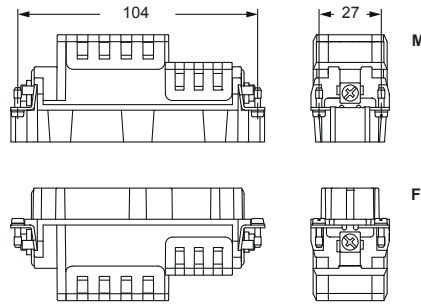

contacts side (front view)

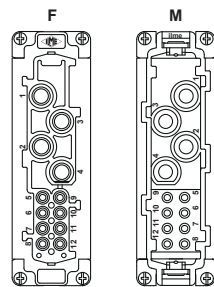

CX7F and CX7M

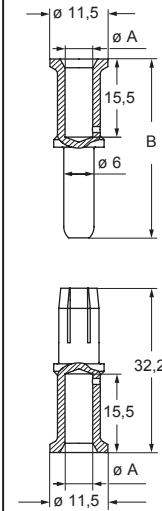

CX7F and CX7M contacts

conductor section (mm <sup>2</sup> )	conductor slot B (mm)	conductor stripping length (mm)
6	3,5	36,0
10	4,3	35,2
16	5,5	35,2
25	7,0	35,2



# CXCF /M 4/8 4 poles (80 A - 400 V) + 8 poles (16 A - 230/400 V) + ⊕

16 A crimp contacts  
silver plated



removal tools



description	part No.	part No.
-------------	----------	----------

16 A female crimp contacts			silver plated	
0,14-0,37 mm <sup>2</sup>	AWG 26-22	one groove		<b>CCFA 0.3</b>
0,5 mm <sup>2</sup>	AWG 20	with no grooves		<b>CCFA 0.5</b>
0,75 mm <sup>2</sup>	AWG 18	one groove (back side)		<b>CCFA 0.7</b>
1 mm <sup>2</sup>	AWG 18	one groove		<b>CCFA 1.0</b>
1,5 mm <sup>2</sup>	AWG 16	two grooves		<b>CCFA 1.5</b>
2,5 mm <sup>2</sup>	AWG 14	three grooves		<b>CCFA 2.5</b>
3 mm <sup>2</sup>	AWG 12	one wide groove		<b>CCFA 3.0</b>
4 mm <sup>2</sup>	AWG 12	with no grooves		<b>CCFA 4.0</b>

16 A male crimp contacts			silver plated	
0,14-0,37 mm <sup>2</sup>	AWG 26-22	one groove		<b>CCMA 0.3</b>
0,5 mm <sup>2</sup>	AWG 20	with no grooves		<b>CCMA 0.5</b>
0,75 mm <sup>2</sup>	AWG 18	one groove (back side)		<b>CCMA 0.7</b>
1 mm <sup>2</sup>	AWG 18	one groove		<b>CCMA 1.0</b>
1,5 mm <sup>2</sup>	AWG 16	two grooves		<b>CCMA 1.5</b>
2,5 mm <sup>2</sup>	AWG 14	three grooves		<b>CCMA 2.5</b>
3 mm <sup>2</sup>	AWG 12	one wide groove		<b>CCMA 3.0</b>
4 mm <sup>2</sup>	AWG 12	with no grooves		<b>CCMA 4.0</b>

removal tools  
for **CX7** series contacts  
for **CC** series contacts

**CX7ES**  
**CQES**

### CCF and CCM

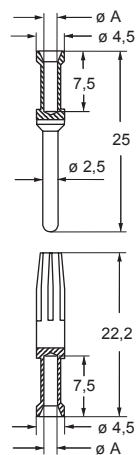

### CCF and CCM contacts

conductor section (mm <sup>2</sup> )	conductor slot $\varnothing A$ (mm)	conductors stripping length (mm)
0,14-0,37	0,9	7,5
0,5	1,1	7,5
0,75	1,3	7,5
1,0	1,45	7,5
1,5	1,8	7,5
2,5	2,2	7,5
3	2,55	7,5
4	2,85	7,5

## FOCUS ON

---

### CX7 CRIMP CONTACTS SERIES CURRENT-CARRYING CAPACITY UP TO 80 A

---



When employed in the new crimp combined connector inserts CXC 4/2 and CXC 4/8, the current-carrying capacity of CX7 crimp contacts rises up to 80 A



Find more information on our products at [www.ilme.com](http://www.ilme.com)

# TECHNICAL FEATURES

## CX7 CRIMP CONTACTS SERIES

### CURRENT-CARRYING CAPACITY UP TO 80 A

Series **CX7** removable crimp contacts have been conventionally described as “70 A contacts”, lacking until now any application other than in series MIXO **CX 02 7F/7M** “70 A” modules.

When employed in the new crimp connector inserts **CXC 4/2** (see page 14-17) and **CXC 4/8** (see page 18-21), which are combined connectors with power contacts up to **80 A**, the **CX7** **current-carrying capacity, only for this specific use, is extended to 80 A**.

As for any series of crimp contacts, the current-carrying capacity depends on:

**- the contact size**

As the mating side (male and female) is standardized, the rear side, consisting of the crimp barrel, is available in four different sizes: 6.0, 10, 16 and 25, and the highest possible working current belongs to the largest contact size and the associated largest conductor cross-sectional area;

**- the target connector insert**

The higher the number of poles loaded in the same enclosure, i.e. the higher the contact density, the lower the available working current before the upper limiting temperature (ULT) of materials is reached, including that of cable sheathing (that has not to be ignored);

**- the connector polarity**

In the same series, a lower number of poles yields to a higher possible working current: a single module produces less heat and lower temperature than 6× the same module.

The **70 A** conventional “nickname” of series **CX7** was then attributed based on the worst case where 6× CX 02 7F/ 7M were used in a size “104.27” MIXO frame CX 06 TF/TM.

However, it is possible that the same **CX7** contacts, in a smaller amount than 12 in a “104.27” housing or 8 in a “77.27” housing, are able to carry up to 80 A, as they do in the new connectors **CXC 4/2** (only 4 power poles in a “77.27” connector) and **CXC 4/8** (only 4 power poles + 8 aux poles in a “104.27” insert).

The **80 A** higher current-carrying capacity, based on the derating diagrams, belongs to the larger 16 mm<sup>2</sup> / 6 AWG and 25 mm<sup>2</sup> / 4-3 AWG cross-sectional area conductors for the new crimp inserts.

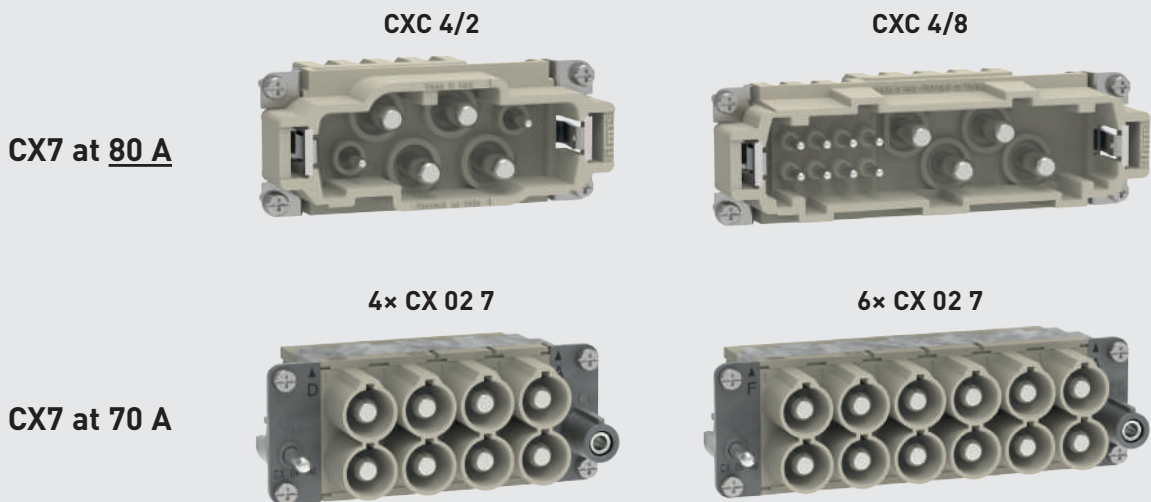

---

## CX SERIES - POWER CRIMP CONNECTOR

### CXF /M 8/0

---

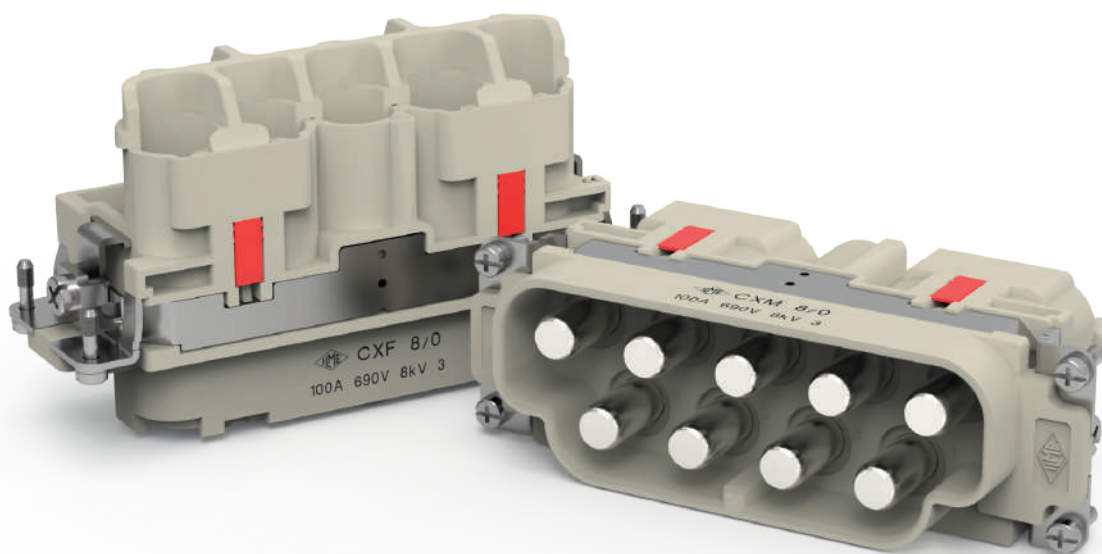

For use with up to 8 (+ 1 for  $\ominus$ )  
removable crimp contacts series CG,  
with working current up to 100 A  
8 poles +  $\ominus$ : 100 A 690 V 8 kV 3



Find more  
information on  
our products at  
[www.ilme.com](http://www.ilme.com)

# TECHNICAL FEATURES

## CXF /M 8/0

For use with up to 8 (+ 1 for ⊕) removable crimp contacts series **CG** (9 contacts required to fill the connector), **for use with working current up to 100 A** (derating diagrams under construction). Series **CG** contacts are available in four sizes (10, 16, 25, 35) covering the corresponding stranded conductor cross-sectional area (mm<sup>2</sup>) (class 5 per IEC 60228) and corresponding AWG.

No auxiliary (signal) contact (in the same size, CX 6/6 has seats for 6 + ⊕ 100 A power contacts series CG and for 6 16 A auxiliary contacts series CC).

Crimp connection technology, providing benefits over the competing axial screw technology:

- higher resistance to mechanical stresses such as vibration, shock and strain on wire strands, e.g. creep due to thermal cycling;
- gas tightness providing outstanding corrosion resistance;
- faster connection time and more consistent results (independence from operator-applied tightening torque);
- higher connector efficiency (lower voltage drop).

Upon insert fitted with crimped connections, the contact holder is firmly locked in place by **four provided locking keys**, red coloured (**proprietary ILME design**), ensuring quick fitting and removal of crimped connections. Removal by simple flat blade screwdriver (e.g. 0,5 x 3 mm, 0,6 x 4 mm or 0,8 x 4 mm).

Inserts made by UL 94V-0 glass reinforced polycarbonate, EN 45545-2:2015 compliant.

Crimping of **CG** series contacts to be carried out with the **hand-operated hydraulic pliers CPPZ C** to be fitted with the suitable locator **CGPZ LOC**. Suitable crimping dies **CGD..C** available on request (see CN.19 p. 720).

**PE power crimp contact** to be fitted in the centre of the insert of the same size of the (up to) 8 line power contacts; thanks to its deeper seat on the female insert it is a FMLB contact (*first-make, last-break*) and is made equipotential, by internal metal spring elements, to the integral outer PE busbar welded to the two lateral PE mounting plates, to bond to earth the enclosure (bonding to PE required for metal enclosures). Additional PE screw terminal with pressure plate for conductors up to 4 mm<sup>2</sup> / 12 AWG on PE plate closer to pole #1.

Interchangeable and intermateable with competitor products (available only with axial screw contacts and limited to 25 mm<sup>2</sup> / 4 AWG).

Power connector suitable for energizing e.g. two 3-phase + N AC motors.

Maximum overall diameter of wires: 11,5 mm (same as for the 6+PE power contacts of CXF/M 6/6 combined connector inserts).

cURus, CSA, CQC, DNV-GL, BV, EAC pending.

**RoHS**: compliant without exemptions.

NOTE - The turned crimp contacts series **CG** are **RoHS** compliant with exemption **6(c)**.

the four provided locking keys, red coloured (proprietary ILME design) firmly lock in place the contact holder

 crimp contacts CG series are separately available

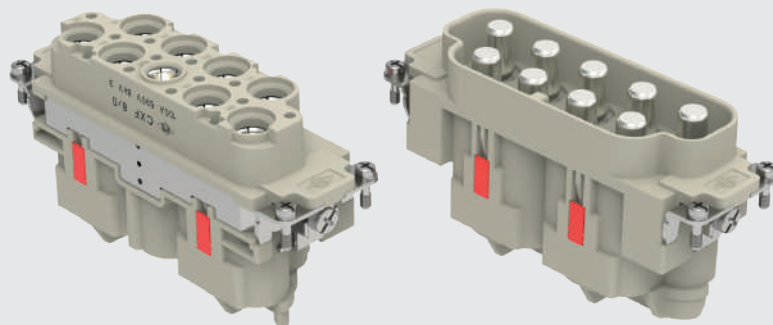

# CXF /M 8/0 8 poles (100 A - 690 V) + ⊕

enclosures:  
size "104.27"

page:

C-TYPE IP65 or IP66/IP69	412 - 423
C7 IP67, two levers	441 - 442
V-TYPE IP65 or IP66/IP69, single lever	459 - 463
BIG hoods	472 - 473
T-TYPE IP65 insulating	486 - 487
T-TYPE / W IP66/IP69 insulating	492
HYGIENIC T-TYPE / H IP66/IP69	504
HYGIENIC T-TYPE / C IP66/IP69, -50 °C	509
W-TYPE for aggressive environments	524
E-Xtreme® corrosion proof	536 - 537, 545, 556 - 557
EMC	581
Central lever	612 - 614
LS-TYPE	624 - 625
IP68	644 - 647

panel supports:

COB 652 - 653

enclosures:  
bulkhead mounting housings, high construction housings  
or high construction hoods

refer to CN.19 pages

inserts, crimp connections



**FROM SEPTEMBER 2021**

100 A crimp contacts  
silver plated



description

part No.

part No.

without contacts (to be ordered separately)  
female inserts for female contacts  
male inserts for male contacts

CXF 8/0  
CXM 8/0

100A female crimp contacts  
8 - 10 mm<sup>2</sup> AWG 8 - 7  
16 mm<sup>2</sup> AWG 6 - 5  
25 mm<sup>2</sup> AWG 4 - 3  
35 mm<sup>2</sup> AWG 2

CGFA 10  
CGFA 16  
CGFA 25  
CGFA 35

100A male crimp contacts  
8 - 10 mm<sup>2</sup> AWG 8 - 7  
16 mm<sup>2</sup> AWG 6 - 5  
25 mm<sup>2</sup> AWG 4 - 3  
35 mm<sup>2</sup> AWG 2

CGMA 10  
CGMA 16  
CGMA 25  
CGMA 35

silver plated

- characteristics according to EN/IEC 61984 ratings:

**100 A 690 V 8 kV 3**

- cURus, CSA, CQC, DNV-GL, BV, EAC pending
- rated voltage according to UL/CSA: 600 V
- insulation resistance: ≥ 10 GΩ
- Lower and Upper Limiting Temperatures (LLT ... ULT):  
-40 °C ... +125 °C
- made by UL 94V-0 glass reinforced polycarbonate,  
EN 45545-2:2015 compliant
- mechanical life: ≥ 500 cycles
- contact resistance: ≤ 0,3 mΩ
- **it is recommended to crimp the contacts with crimping tools homologated by ILME** (please see the crimping tool section 100 A contacts CGF, CGM series, on pages 708 - 741 of CN.19 catalogue).
- for max. current load see the connector inserts derating diagrams **under construction**.

CXF 8/0, CXM 8/0

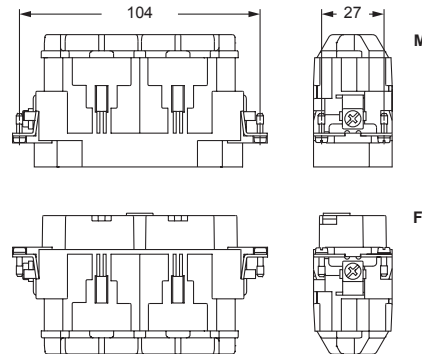

contacts side (front view)

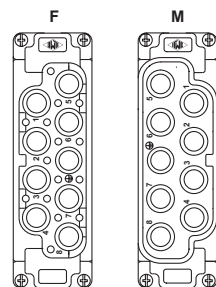

CGF and CGM

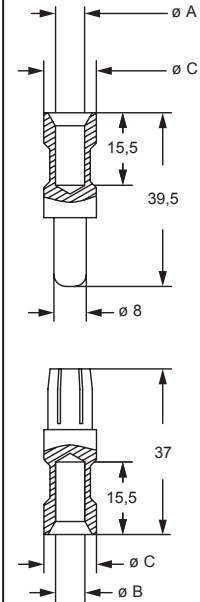

CGF and CGM contacts

conductor section (mm <sup>2</sup> )	conductor slot ø A (mm)	conductor slot ø B (mm)	conductor slot ø C (mm)	conductor stripping length (mm)
8-10	4,3	4,3	13	15
16	5,5	5,5	13	15
25	7,0	7,0	13	15
35	7,9	8,2	12,5	15

# ASSEMBLY INSTRUCTIONS

CXF /M 8/0

NOTE: CXF 8/0 representative also of CXM 8/0

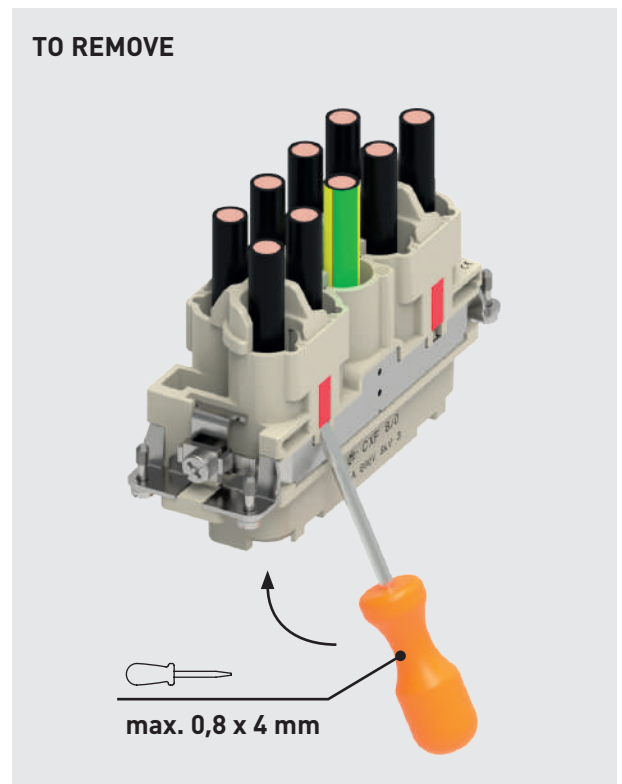
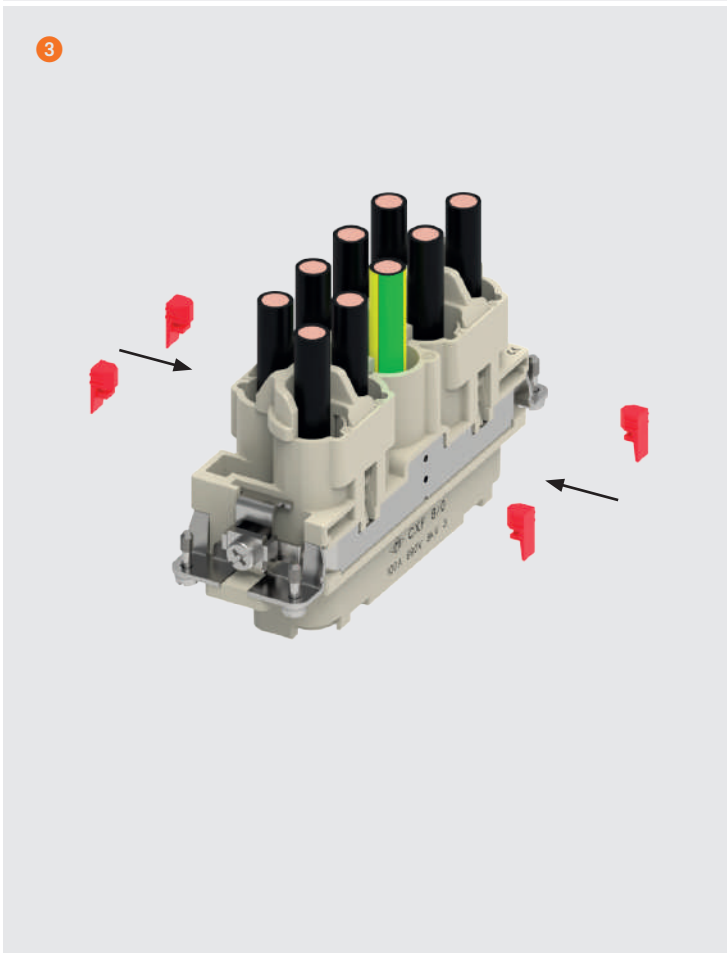
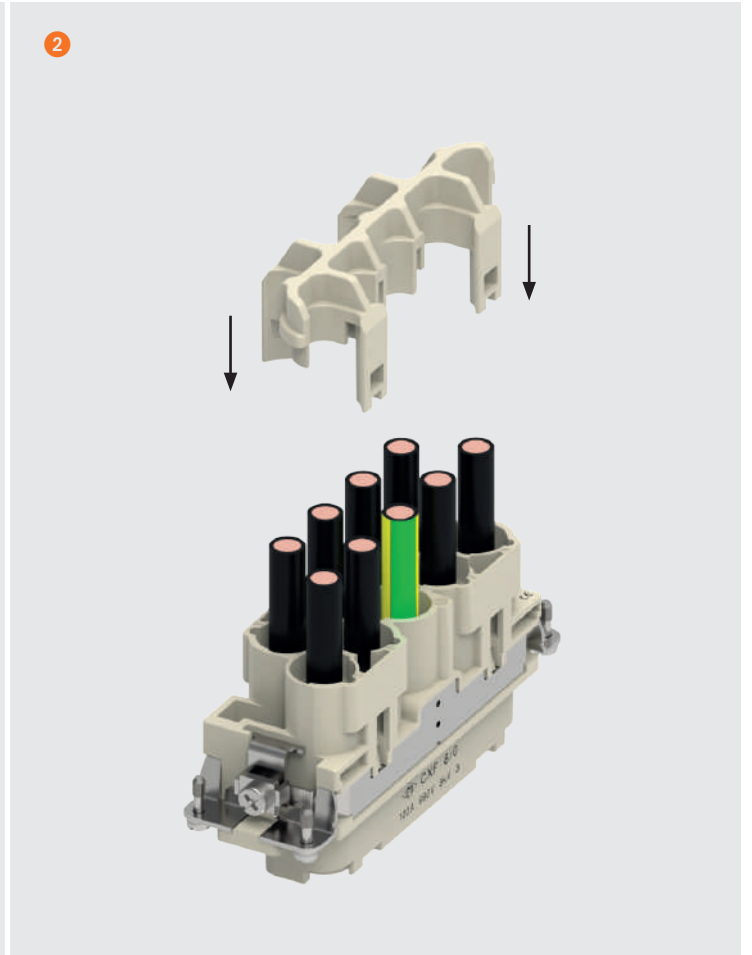
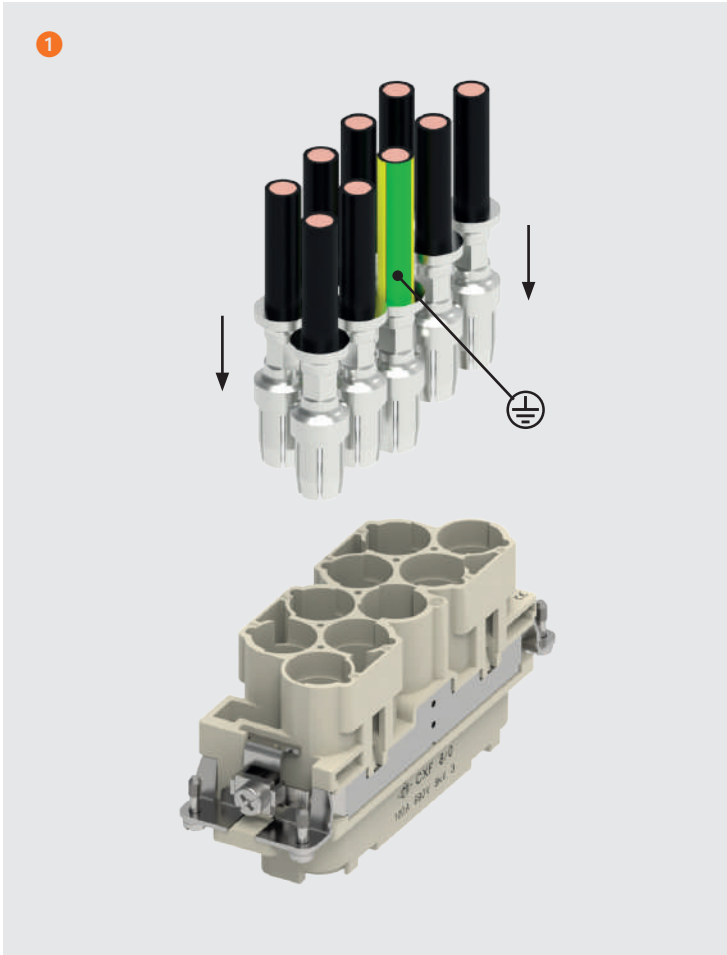



---

## RSH-SQUICH® CONNECTOR SERIES

### HNM VERSION

RSHF /M 06 / 10 / 16 / 24

---

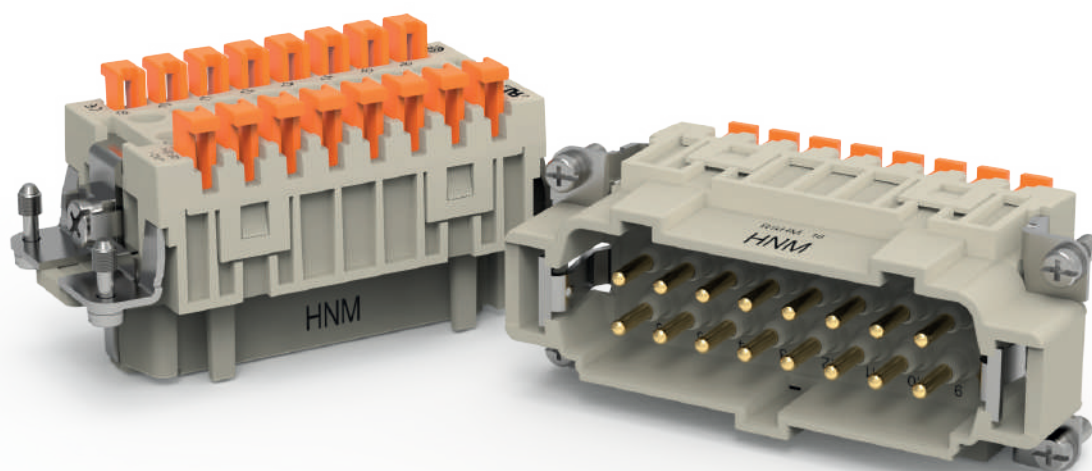

RSH-SQUICH® Series  
(HNM version of CSH-SQUICH®)  
16 A 500 V 6 kV 3



Find more  
information on  
our products at  
[www.ilme.com](http://www.ilme.com)



## TECHNICAL FEATURES

### RSHF /M 06 / 10 / 16 / 24

The new **RSH-SQUICH**® is the HNM (High Number of Matings) version of the original **CSH-SQUICH**® series.

Inherits all benefits of the ILME proprietary SQUICH® technology: operator skill independence, fast and reliable wiring, high resistance to vibration.

Boosts mechanical lifecycle of **CSH** from  $\geq 500$  to 10.000 cycles of **RSH**, for applications requiring frequent connection and disconnection (e.g. measuring/controlling drawer-mounted equipment, control equipment on moulds and replaceable tools, etc.).

- Available in four classical sizes "44.27" (6-pole) through "104.27" (24-pole).

NOTE – 2-insert combinations "77.62" (32-pole) or "104.62" (48-pole) not available: size "77.62" and "104.62" enclosures are not foreseen in the HNM range.

- Same ratings (voltage, current including derating diagrams, range of conductor cross-sectional areas, limiting temperatures) as series **CSH**.

- Suitable for up to **10.000 operating cycles** when installed in compatible HNM enclosures, equally rated (10.000 locking and unlocking cycles).

- Spring clamp contacts with actuator pushbutton, selectively high thickness gold plated and specially lubricated.

- Lateral sliding PE contacts specially lubricated.

- Identified by specific **RSH..** part No. and **HNM** on the insert.

- Interchangeable and intermateable with already available series **RCE** (crimp) HNM inserts.

- cURus, CSA, CQC, DNV-GL, BV, EAC pending.

- **RoHS**: compliant with exemption **6(c)**.

special gold plating and lubrication to reduce the wear of the contacts during frequently repeated mating/unmating operations

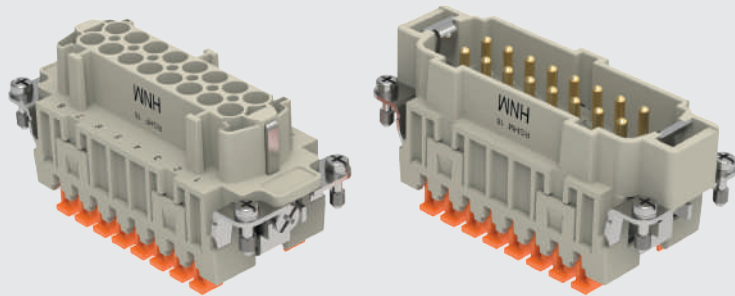

# RSH-SQUICH® 6 poles + ⊕ 16 A - 500 V HNM (High Number of Matings)

enclosures:  
size "44.27"

page:

HNM

592 - 593

inserts,  
spring terminal connections without tools

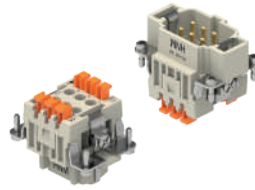

Q 10 000 MATINGS WITH HNM ENCLOSURES

FROM JUNE 2021

refer to CN.19 pages

description

part No.

spring terminals with actuator button  
female inserts with female contacts  
male inserts with male contacts

RSHF 06  
RSHM 06

- characteristics according to EN 61984:  
**16 A 500 V 6 kV 3**
- cURus, CSA, CQC, DNV-GL, BV, EAC pending
- rated voltage according to UL/CSA: 600 V
- insulation resistance:  $\geq 10 \text{ G}\Omega$
- ambient temperature limit:  $-40 \text{ }^\circ\text{C} \dots +125 \text{ }^\circ\text{C}$
- made of self-extinguishing thermoplastic resin UL 94V-0
- mechanical life:  $\geq 10.000$  cycles
- contact resistance:  $\leq 3 \text{ m}\Omega$
- for max. current load see the connector inserts derating diagrams below; for more information see page 28 of CN.19 catalogue

RSH 06

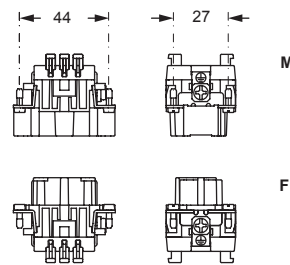

contacts side (front view)

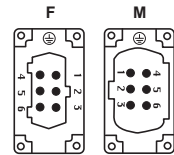

- inserts for conductors with the following sections:  
0,14 - 2,5 mm<sup>2</sup> - AWG 26 - 14
- conductors stripping length: 7 mm

RSH 06 poles connector inserts  
Maximum current load derating diagram

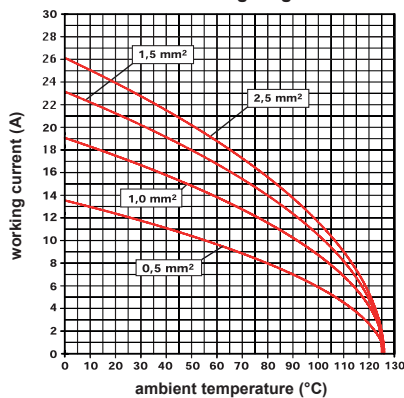

SQUICH®-spring connection technology

WIRING

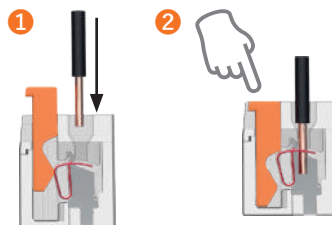

1 Deeply insert a stripped conductor into a round terminal.

2 Push the actuator button to close the terminal.

RE-OPENING

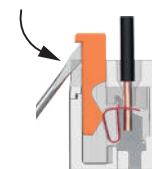

Insert a **0,5 x 3,5 mm** flat blade screwdriver in the actuator button side window and pull it up by levering down.

# RSH-SQUICH® 10 poles + ⚡ 16 A - 500 V HNM (High Number of Matings)

enclosures:  
size "57.27"

page:

HNM

594 - 595

inserts,  
spring terminal connections without tools

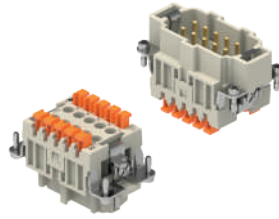

Q 10 000 MATINGS WITH HNM ENCLOSURES

📅 FROM JUNE 2021

refer to CN.19 pages

description

part No.

spring terminals with actuator button  
female inserts with female contacts  
male inserts with male contacts

**RSHF 10**  
**RSHM 10**

- characteristics according to EN 61984:  
**16 A 500 V 6 kV 3**
- cURus, CSA, CQC, DNV-GL, BV, EAC pending
- rated voltage according to UL/CSA: 600 V
- insulation resistance:  $\geq 10 \text{ G}\Omega$
- ambient temperature limit:  $-40 \text{ }^\circ\text{C} \dots +125 \text{ }^\circ\text{C}$
- made of self-extinguishing thermoplastic resin UL 94V-0
- mechanical life:  $\geq 10.000$  cycles
- contact resistance:  $\leq 3 \text{ m}\Omega$
- for max. current load see the connector inserts derating diagrams below; for more information see page 28 of CN.19 catalogue

**RSH 10**

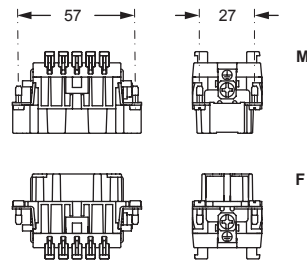

contacts side (front view)

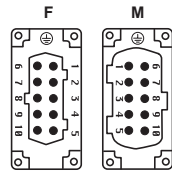

- inserts for conductors with the following sections:  
0,14 - 2,5 mm<sup>2</sup> - AWG 26 - 14
- conductors stripping length: 7 mm

**RSH 10 poles connector inserts**  
Maximum current load derating diagram

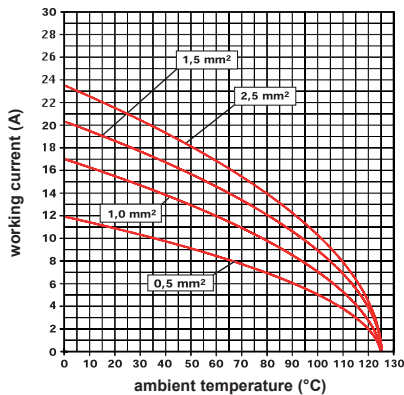

**SQUICH®-spring connection technology**

**WIRING**

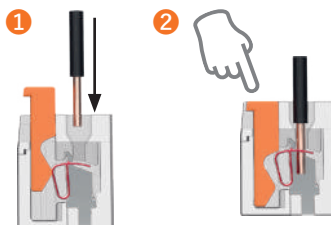

1 Deeply insert a stripped conductor into a round terminal.

2 Push the actuator button to close the terminal.

**RE-OPENING**

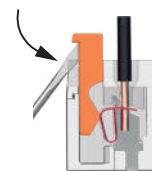

Insert a **0,5 x 3,5 mm** flat blade screwdriver in the actuator button side window and pull it up by levering down.

# RSH-SQUICH® 16 poles + ⚡ 16 A - 500 V HNM (High Number of Matings)

enclosures:  
size "77.27"

page:

HNM

596 - 597

inserts,  
spring terminal connections without tools

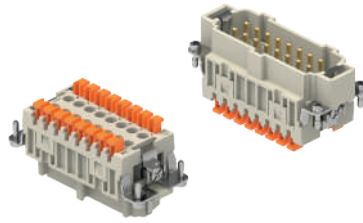

Q 10 000 MATINGS WITH HNM ENCLOSURES

FROM JUNE 2021

refer to CN.19 pages

description

part No.

spring terminals with actuator button  
female inserts with female contacts  
male inserts with male contacts

RSHF 16  
RSHM 16

- characteristics according to EN 61984:  
**16 A 500 V 6 kV 3**
- cURus, CSA, CQC, DNV-GL, BV, EAC pending
- rated voltage according to UL/CSA: 600 V
- insulation resistance:  $\geq 10 \text{ G}\Omega$
- ambient temperature limit:  $-40 \text{ }^\circ\text{C} \dots +125 \text{ }^\circ\text{C}$
- made of self-extinguishing thermoplastic resin UL 94V-0
- mechanical life:  $\geq 10.000$  cycles
- contact resistance:  $\leq 3 \text{ m}\Omega$
- for max. current load see the connector inserts derating diagrams below; for more information see page 28 of CN.19 catalogue

RSH 16

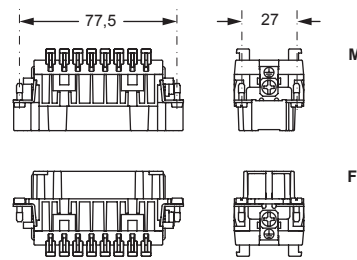

contacts side (front view)

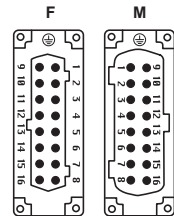

- inserts for conductors with the following sections:  
0,14 - 2,5 mm<sup>2</sup> - AWG 26 - 14
- conductors stripping length: 7 mm

RSH 16 poles connector inserts  
Maximum current load derating diagram

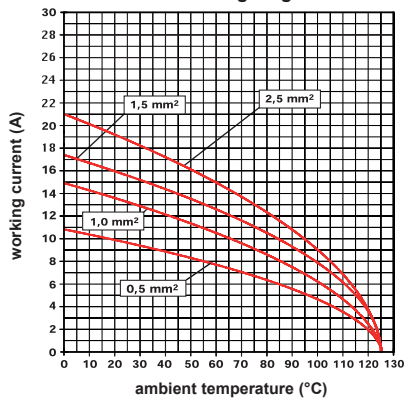

SQUICH®-spring connection technology

WIRING

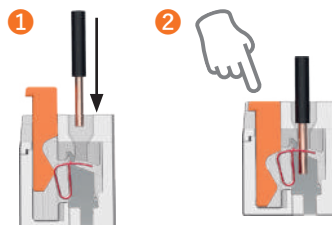

1 Deeply insert a stripped conductor into a round terminal.

2 Push the actuator button to close the terminal.

RE-OPENING

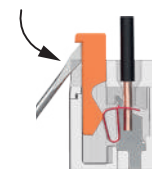

Insert a **0,5 x 3,5 mm** flat blade screwdriver in the actuator button side window and pull it up by levering down.

# RSH-SQUICH® 24 poles + ⚡ 16 A - 500 V HNM (High Number of Matings)

enclosures:  
size "104.27"

page:

HNM

598 - 599

inserts,  
spring terminal connections without tools

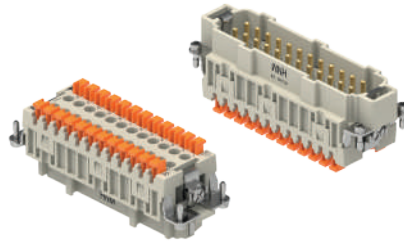

Q 10 000 MATINGS WITH HNM ENCLOSURES

FROM JUNE 2021

refer to CN.19 pages

description

part No.

spring terminals with actuator button  
female inserts with female contacts  
male inserts with male contacts

RSHF 24  
RSHM 24

- characteristics according to EN 61984:  
**16 A 500 V 6 kV 3**
- cURus, CSA, CQC, DNV-GL, BV, EAC pending
- rated voltage according to UL/CSA: 600 V
- insulation resistance:  $\geq 10 \text{ G}\Omega$
- ambient temperature limit:  $-40 \text{ }^\circ\text{C} \dots +125 \text{ }^\circ\text{C}$
- made of self-extinguishing thermoplastic resin UL 94V-0
- mechanical life:  $\geq 10.000$  cycles
- contact resistance:  $\leq 3 \text{ m}\Omega$
- for max. current load see the connector inserts derating diagrams below; for more information see page 28 of CN.19 catalogue

RSH 24

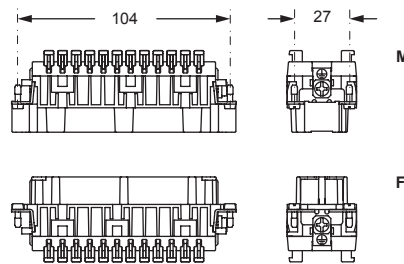

contacts side (front view)

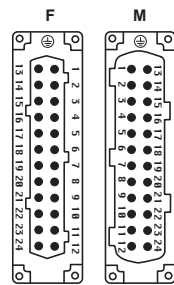

- inserts for conductors with the following sections:  
0,14 - 2,5 mm<sup>2</sup> - AWG 26 - 14
- conductors stripping length: 7 mm

RSH 24 poles connector inserts  
Maximum current load derating diagram

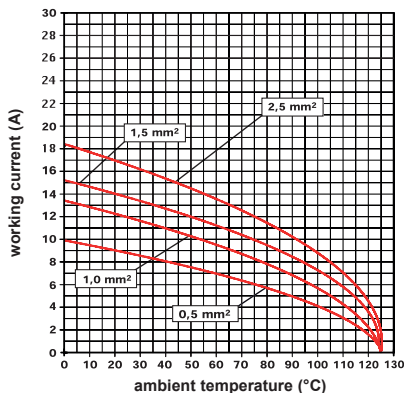

SQUICH®-spring connection technology

WIRING

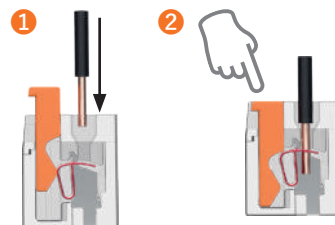

1 Deeply insert a stripped conductor into a round terminal.

2 Push the actuator button to close the terminal.

RE-OPENING

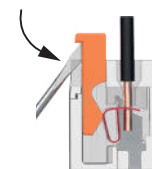

Insert a **0,5 x 3,5 mm** flat blade screwdriver in the actuator button side window and pull it up by levering down.

---

## RDSH-SQUICH® CONNECTOR SERIES

### HNM VERSION

RDSHF /M 09 / 18 / 27 / 42

---

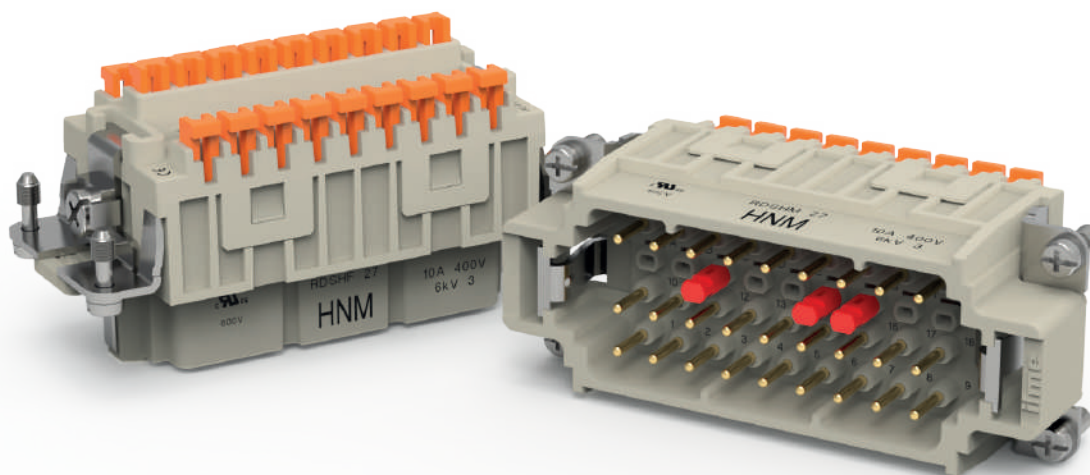

RDSH-SQUICH® Series  
(HNM version of CDSH-SQUICH®)

10 A 400 V 6 kV 3

10 A 400/690 V 6 kV 2



Find more  
information on  
our products at  
[www.ilme.com](http://www.ilme.com)

## TECHNICAL FEATURES

### RDSHF /M 09 / 18 / 27 / 42

The new **RDSH-SQUICH®** is the HNM (High Number of Matings) version of the original **CDSH-SQUICH®** series.

Inherits all benefits of the ILME proprietary SQUICH® technology also in its most compact evolution: operator skill independence, fast and reliable wiring, high resistance to vibration.

Boosts mechanical lifecycle of **CDSH** from  $\geq 500$  to 10.000 cycles of **RDSH**, for applications requiring the higher density of contacts of this series (up to 42-pole in the "104.27" size) and frequent connection and disconnection (e.g. measuring/controlling drawer-mounted equipment, control equipment on moulds and replaceable tools, etc.).

- Available in four classical sizes "44.27" (6-pole) through "104.27" (24-pole).

NOTE – 2-insert combinations "77.62" (54-pole) and "104.62" (84-pole) not available, as size "77.62" and "104.62" enclosures are not foreseen in the HNM range.

- Same ratings (voltage, current including derating diagrams, range of conductor cross-sectional areas, limiting temperatures) as **CDSH**.
- Suitable for up to **10.000 operating cycles** when installed in compatible HNM enclosures, equally rated (10.000 locking and unlocking cycles).
- Spring clamp contacts with actuator pushbutton, selectively high thickness gold plated and specially lubricated.
- Lateral sliding PE contacts specially lubricated.
- Identified by specific **RDSH...** part No. and **HNM** on the insert.
- **CR CDS** plastic coding pin that enables the polarisation of inserts in a wide range of combinations.
- cURus, CSA, CQC, DNV-GL, BV, EAC pending.
- **RoHS**: compliant with exemption **6(c)**.

spring clamp contacts with actuator pushbutton, selectively high thickness gold plated and specially lubricated

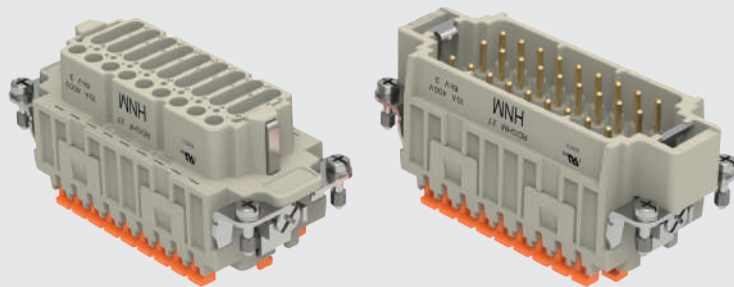



# RDSH-SQUICH® 9 poles + ⊕ 10 A - 400 V HNM (High Number of Matings)

enclosures:  
size "44.27"

page:

HNM

592 - 593

inserts,  
spring terminal connections without tools

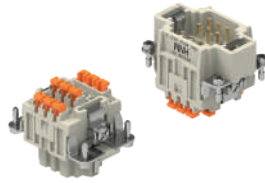

Q 10 000 MATINGS WITH HNM ENCLOSURES

FROM JUNE 2021

coding pins



refer to CN.19 pages

description

part No.

part No.

spring terminals with actuator button  
female inserts with female contacts  
male inserts with male contacts

RDSHF 09  
RDSHM 09

plastic coding pins

CR CDS

- characteristics according to EN 61984:  
**10 A 400 V 6 kV 3**  
**10 A 400/690 V 6 kV 2**
- cURus, CSA, CQC, DNV-GL, BV, EAC pending
- rated voltage according to UL/CSA: 600 V
- insulation resistance:  $\geq 10 \text{ G}\Omega$
- ambient temperature limit:  $-40 \text{ }^\circ\text{C} \dots +125 \text{ }^\circ\text{C}$
- made of self-extinguishing thermoplastic resin UL 94V-0
- mechanical life:  $\geq 10.000$  cycles
- contact resistance:  $\leq 3 \text{ m}\Omega$
- for max. current load see the connector inserts derating diagram below; for more information see page 28 of CN.19 catalogue

RDSH 09

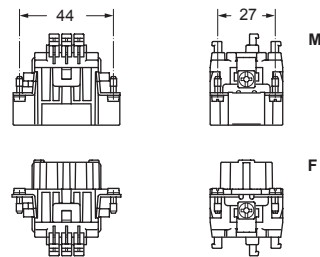

contacts side (front view)

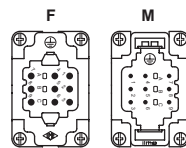

- inserts for conductors cross-sectional areas:  
0,14 - 2,5 mm<sup>2</sup> - AWG 26 - 14
- for wires with crimped ferrule, usable section:  
up to 1,5 mm<sup>2</sup> (AWG 16)
- conductors stripping length: 9...11 mm

CR CDS

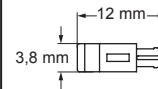

RDSH series - Coding with CR CDS pins

Size of connectors	Slots for coding pins (M) = male insert (F) = female insert	Required coding pins for each coupling	Possible codings
9P + ⊕	3 (M) + 3 (F)	3 2 (M) + 1 (F)	3

RDSH 09 poles connector inserts  
Maximum current load derating diagram

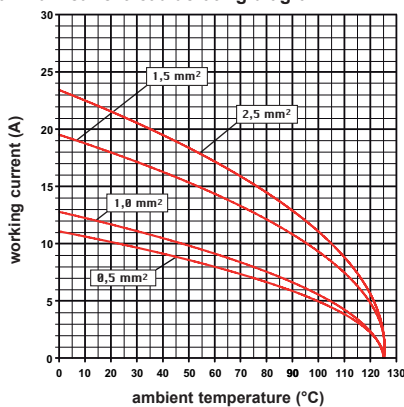

SQUICH®-spring connection technology

WIRING

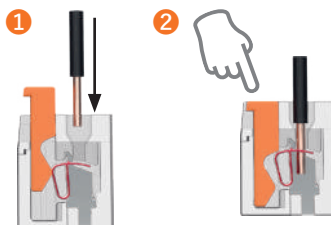

1 Deeply insert a stripped conductor into a round terminal.

2 Push the actuator button to close the terminal.

RE-OPENING

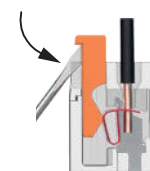

Insert a 0,5 x 3,5 mm flat blade screwdriver in the actuator button side window and pull it up by levering down.



# RDSH-SQUICH® 18 poles + ⊕ 10 A - 400 V HNM (High Number of Matings)

enclosures:  
size "57.27"

page:

HNM

594 - 595

inserts,  
spring terminal connections without tools

coding pins

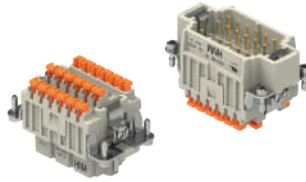

Q 10 000 MATINGS WITH HNM ENCLOSURES

FROM JUNE 2021

refer to CN.19 pages

description

part No.

part No.

spring terminals with actuator button  
female inserts with female contacts  
male inserts with male contacts

RDSHF 18  
RDSHM 18

plastic coding pins

CR CDS

- characteristics according to EN 61984:  
**10 A 400 V 6 kV 3**  
**10 A 400/690 V 6 kV 2**
- cURus, CSA, CQC, DNV-GL, BV, EAC pending
- rated voltage according to UL/CSA: 600 V
- insulation resistance:  $\geq 10 \text{ G}\Omega$
- ambient temperature limit:  $-40 \text{ }^\circ\text{C} \dots +125 \text{ }^\circ\text{C}$
- made of self-extinguishing thermoplastic resin UL 94V-0
- mechanical life:  $\geq 10.000$  cycles
- contact resistance:  $\leq 3 \text{ m}\Omega$
- for max. current load see the connector inserts derating diagram below; for more information see page 28 of CN.19 catalogue

RDSH 18

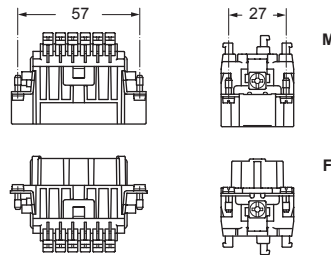

contacts side (front view)

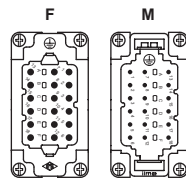

- inserts for conductors cross-sectional areas:  
0,14 - 2,5 mm<sup>2</sup> - AWG 26 - 14
- for wires with crimped ferrule, usable section:  
up to 1,5 mm<sup>2</sup> (AWG 16)
- conductors stripping length: 9...11 mm

CR CDS

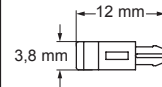

RDSH series - Coding with CR CDS pins

Size of connectors	Slots for coding pins (M) = male insert (F) = female insert	Required coding pins for each coupling	Possible codings
18P + ⊕	6 (M) + 6 (F)	6 3 (M) + 3 (F)	20

RDSH 18 poles connector inserts  
Maximum current load derating diagram

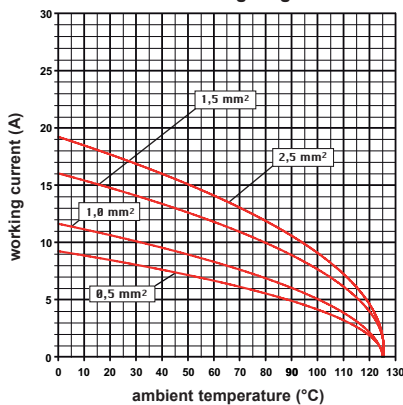

SQUICH®-spring connection technology

WIRING

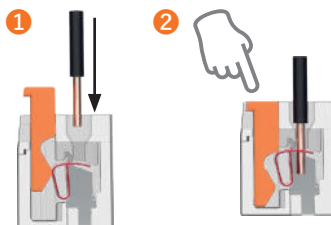

1. Deeply insert a stripped conductor into a round terminal.

2. Push the actuator button to close the terminal.

RE-OPENING

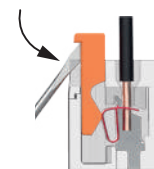

Insert a 0,5 x 3,5 mm flat blade screwdriver in the actuator button side window and pull it up by levering down.

# RDSH-SQUICH® 27 poles + ⊕ 10 A - 400 V HNM (High Number of Matings)

enclosures:  
size "77.27"

page:

HNM

596 - 597

inserts,  
spring terminal connections without tools

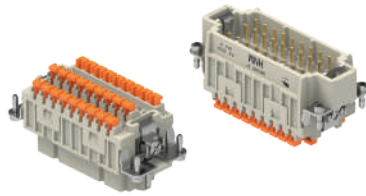

Q 10 000 MATINGS WITH HNM ENCLOSURES

FROM JUNE 2021

coding pins



refer to CN.19 pages

description

part No.

part No.

spring terminals with actuator button  
female inserts with female contacts  
male inserts with male contacts

RDSHF 27  
RDSHM 27

plastic coding pins

CR CDS

- characteristics according to EN 61984:

**10 A 400 V 6 kV 3**  
**10 A 400/690 V 6 kV 2**

- cURus, CSA, CQC, DNV-GL, BV, EAC pending
- rated voltage according to UL/CSA: 600 V
- insulation resistance:  $\geq 10 \text{ G}\Omega$
- ambient temperature limit:  $-40 \text{ }^\circ\text{C} \dots +125 \text{ }^\circ\text{C}$
- made of self-extinguishing thermoplastic resin UL 94V-0
- mechanical life:  $\geq 10.000$  cycles
- contact resistance:  $\leq 3 \text{ m}\Omega$
- for max. current load see the connector inserts derating diagram below; for more information see page 28 of CN.19 catalogue

RDSH 27

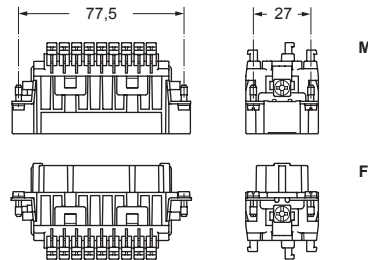

contacts side (front view)

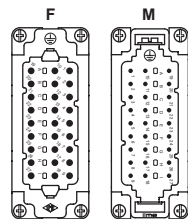

- inserts for conductors cross-sectional areas: 0,14 - 2,5 mm<sup>2</sup> - AWG 26 - 14
- for wires with crimped ferrule, usable section: up to 1,5 mm<sup>2</sup> (AWG 16)
- conductors stripping length: 9...11 mm

CR CDS

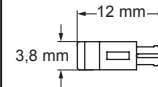

RDSH series - Coding with CR CDS pins

Size of connectors	Slots for coding pins (M) = male insert (F) = female insert	Required coding pins for each coupling	Possible codings
27P + ⊕	9 (M) + 9 (F)	9 5 (M) + 4 (F)	126

RDSH 27 poles connector inserts  
Maximum current load derating diagram

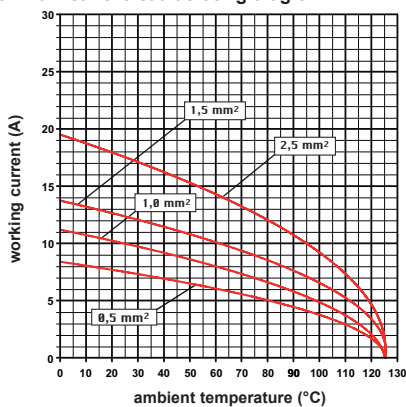

SQUICH®-spring connection technology

WIRING

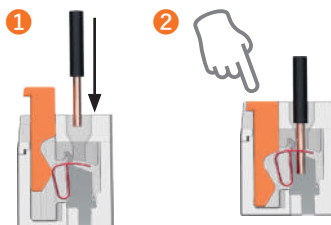

1 Deeply insert a stripped conductor into a round terminal.

2 Push the actuator button to close the terminal.

RE-OPENING

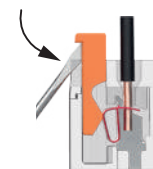

Insert a **0,5 x 3,5 mm** flat blade screwdriver in the actuator button side window and pull it up by levering down.

# RDSH-SQUICH® 42 poles + ⊕ 10 A - 400 V HNM (High Number of Matings)

enclosures:  
size "104.27"

page:

HNM

598 - 599

inserts,  
spring terminal connections without tools

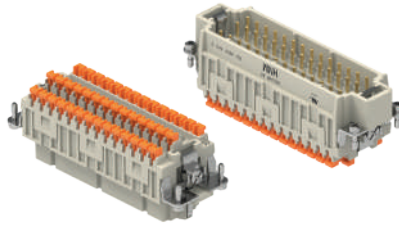

Q 10 000 MATINGS WITH HNM ENCLOSURES

FROM JUNE 2021

coding pins



refer to CN.19 pages

description

part No.

part No.

spring terminals with actuator button  
female inserts with female contacts  
male inserts with male contacts

RDSHF 42  
RDSHM 42

plastic coding pins

CR CDS

- characteristics according to EN 61984:  
**10 A 400 V 6 kV 3**  
**10 A 400/690 V 6 kV 2**
- cURus, CSA, CQC, DNV-GL, BV, EAC pending
- rated voltage according to UL/CSA: 600 V
- insulation resistance:  $\geq 10 \text{ G}\Omega$
- ambient temperature limit:  $-40 \text{ }^\circ\text{C} \dots +125 \text{ }^\circ\text{C}$
- made of self-extinguishing thermoplastic resin UL 94V-0
- mechanical life:  $\geq 10.000$  cycles
- contact resistance:  $\leq 3 \text{ m}\Omega$
- for max. current load see the connector inserts derating diagram below; for more information see page 28 of CN.19 catalogue

RDSH 42

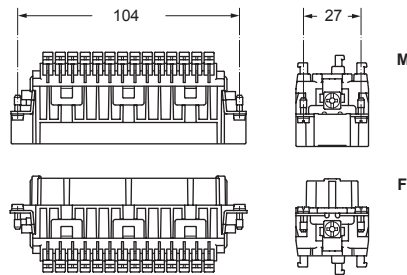

contacts side (front view)

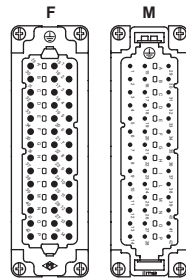

- inserts for conductors cross-sectional areas: 0,14 - 2,5 mm<sup>2</sup> - AWG 26 - 14
- for wires with crimped ferrule, usable section: up to 1,5 mm<sup>2</sup> (AWG 16)
- conductors stripping length: 9...11 mm

CR CDS

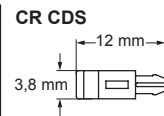

RDSH series - Coding with CR CDS pins

Size of connectors	Slots for coding pins (M) = male insert (F) = female insert	Required coding pins for each coupling	Possible codings
42P + ⊕	14 (M) + 14 (F)	14 7 (M) + 7 (F)	3.432

RDSH 42 poles connector inserts  
Maximum current load derating diagram

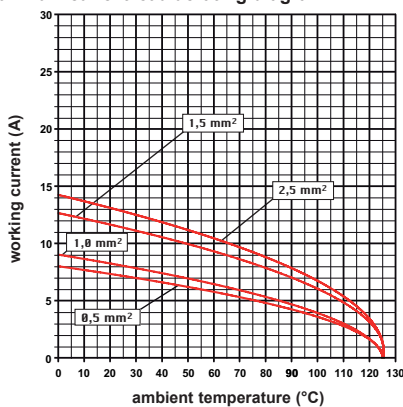

SQUICH®-spring connection technology

WIRING

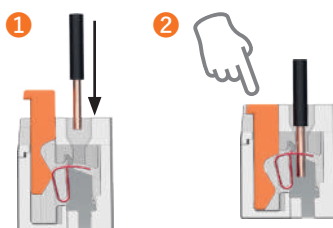

1 Deeply insert a stripped conductor into a round terminal.

2 Push the actuator button to close the terminal.

RE-OPENING

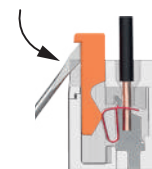

Insert a 0,5 x 3,5 mm flat blade screwdriver in the actuator button side window and pull it up by levering down.

# MIXO SERIES

## GENERAL OVERVIEW

The MIXO series is a system of modular units for special applications that uses the traditional ILME enclosures. Each enclosure can house different types of connections such as: electric signals and contacts for the conduction of compressed air with pressure values of up to 8 bars.

The inserts are arranged side by side to form a single **compact block** which is inserted into metallic frames with constrained positioning. Once the modules have been inserted and locked with the special tabs, the connector can be placed into the enclosure.

The modular system makes it easy to access a series of contacts inserted in the frame (e.g., for substitution, check or the addition of signals with new inserts for needs not foreseen during the initial installation) without having to disassemble the entire connector.

ILME MIXO series of modular connectors is an open connector system that provides versatile configuration to the users' individual requirements, giving the **freedom to assemble a customized connector** from a range of 63 modules for power electrical, data transmission, optical signals or air. The module range is continuously expanded, allowing new configurations to be realised.

The use of enclosures provides the possibility of innumerable **applications.**

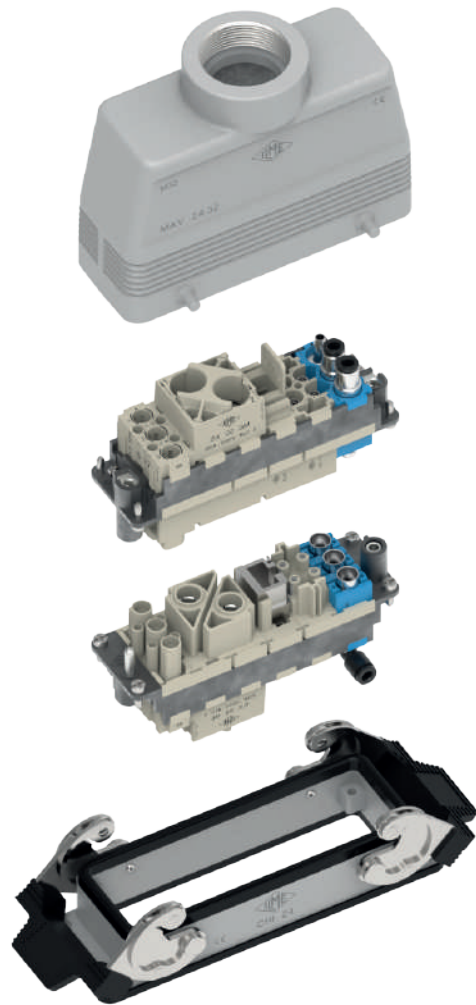

POWER/  
SIGNAL

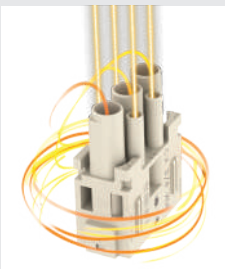

POWER

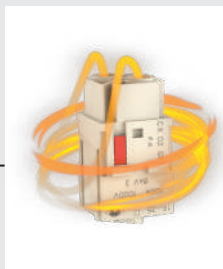

DATA  
TRANSMISSION



FIBRE OPTIC



PNEUMATIC



The MIXO series can be used with **5 different frame sizes**:

Frames	one or two-lever metallic enclosures
<b>CX 01 T</b>	size "49.16"
<b>CX 02 TM/TF</b>	size "44.27"
<b>CX 03 TM/TF</b>	size "57.27"
<b>CX 04 TM/TF</b>	size "77.27"
<b>CX 06 TM/TF</b>	size "104.27"
<b>CX 04 TM/TF (x 2)</b>	size "77.62"
<b>CX 06 TM/TF (x 2)</b>	size "104.62"

Single sized modules, where specified, can also be installed directly inside **MIXO ONE** enclosures.

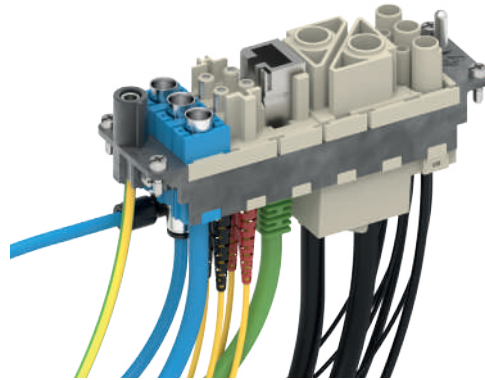

**CX 01 T**  
1 module



**CX 02 TF/TM**  
2 modules



**CX 04 TF/TM**  
4 modules



**CX 03 TF/TM**  
3 modules



**CX 06 TF/TM**  
6 modules



Possibility – to be verified case-by-case – to use the recently added MIXO **HNM frames** (provided with special gold plated PE contacts) together with R series of crimp contacts and the relevant

connector hoods and housings, to produce, where required, an **HNM connector** (High Number of Matings, up to 10.000 cycles of operation).

Fill the unused frame slots with **CX FM dummy module**



In addition, the MIXO series can be used with the **COB series panel supports**.

Frames	COB panel supports part No.
<b>CX 02 TM/TF</b>	fixed: <b>COB 06 BC</b> and <b>COB TCQ</b> mobile: <b>COB TSF, COB TSFS</b> and <b>COB 06 CMS</b>
<b>CX 03 TM/TF</b>	fixed: <b>COB 10 BC</b> and <b>COB TCQ</b> mobile: <b>COB TSF, COB TSFS</b> and <b>COB 10 CMS</b>

Frames	COB panel supports part No.
<b>CX 04 TM/TF</b>	fixed: <b>COB 16 BC</b> and <b>COB TCQ</b> mobile: <b>COB TSF, COB TSFS</b> and <b>COB 16 CMS</b>
<b>CX 06 TM/TF</b>	fixed: <b>COB 24 BC</b> and <b>COB TCQ</b> mobile: <b>COB TSF, COB TSFS</b> and <b>COB 24 CMS</b>

# THE COMPLETE RANGE

2021 products are marked with the **+** symbol.

Calculate the number of frame slots taken up by the required inserts (frame slot 1, 2 or 3 modules) and select the right frame according to the number of required modules (available 1, 2, 3, 4 and 6 modules).

Single sized modules, where specified, can also be installed directly inside **MIXO ONE** enclosures.

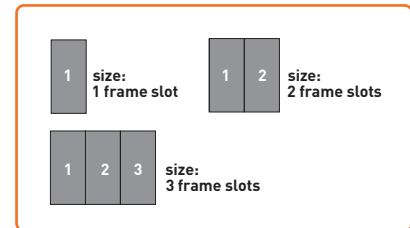

Inserts	Contact type	Signal type	Kind of connection	Rated current (A)	Rated voltage (V)	Number of frame slots
CX 01 YF/M	main	electric	crimp	200	1000	2
CX 01 YPEF/M	PE	—	crimp	200	—	2
CX 01 GF/M	main	electric	crimp	100	830	1
CX 02 GF/M	main	electric	crimp	100	1000	2
CX 02 7F/M	main	electric	crimp	70	1000	1
CX 02 4AF/M	main	electric	axial screw	40	1000	1
CX 02 4BF/M	main	electric	axial screw	40	1000	1
CX 02 4F/M	main	electric	crimp	40	1000	1
CX 03 4F/M	main	electric	crimp	40	400/690	1
CX 03 4BF/BM	main	electric	crimp	40	500	1
CX 3/4 XDF/M	main / auxiliary	electric	crimp	40/10	830	1
CX 04 XF/M	main	electric	crimp	40	830	1
CX 05 SF/M ▲	main	electric	spring	16	400	1
CX 05 SHF/M	main	electric	SQUICH®-spring	16	400	1
CX 06 CF/M	main	electric	crimp	16	500	1
CX 06P CF/M	main	electric	crimp	16	830	1
CX 08 CF/M	main	electric	crimp	16	400	1
CX 08 16F/M	main + shield	electric	crimp	5	50	1
<b>+</b> CX 08 16GF/16GM	main + shield	electric	crimp	5	50	1
RX 08 16F/M (HNM)	main + shield	electric	crimp	5	50	1
<b>+</b> RX 08 16GF/16GM (HNM)	main + shield	electric	crimp	5	50	1
CX 08 D5F/F2 M/M2	main + shield	electric	crimp	10	50	1
<b>+</b> CX 08 D5GF/F2 GM/GM2	main + shield	electric	crimp	10	50	1
RX 08 D5F/F2 M/M2 (HNM)	main + shield	electric	crimp	10	50	1
<b>+</b> RX 08 D5GF/F2 GM/GM2 (HNM)	main + shield	electric	crimp	10	50	1
CX 20 CF/M	main	electric	crimp	16	500	2
CX 12 DF/M	main / auxiliary	electric	crimp	10	250	1
CX 17 DF/M	main / auxiliary	electric	crimp	10	160	1
CX 42 DF/M	main / auxiliary	electric	crimp	10	150	2
CX 25 1BF/M	main / auxiliary	electric	crimp	4	50	1
CX 25 1F/M ▲	main / auxiliary	electric	crimp	4	50	1
CX 20S 1F/M	main / auxiliary + shield	electric	crimp	4	32	1
<b>+</b> CX 20S 1GF/1GM	main / auxiliary + shield	electric	crimp	4	32	1
RX 20S 1F/M (HNM)	main / auxiliary + shield	electric	crimp	4	32	1
<b>+</b> RX 20S 1GF/1GM (HNM)	main / auxiliary + shield	electric	crimp	4	32	1
CX 36 1F/M	main / auxiliary	electric	crimp	4	32	1
CX 02 CHF/M	main	electric	crimp	16	2500	1
CX 02 HF/M	main	electric	crimp	16	2900 / 5000	2
CX 02 4HF/M	main	electric	crimp	40	2900 / 5000	2
CX 02 BF/M	seat for two shielded connectors (refer to CX 04 B, CX 01 B, CX 01 BC, CX 08 B)					2
CX 01 BCF/M	main / auxiliary + shield	electric	crimp	16	50	—
CX 01 BF/M	main / auxiliary + shield	electric	crimp	10	50	—
CX 04 BF/M	main / auxiliary + shield	electric	crimp	10	50	—
CX 08 BF/M	main / auxiliary + shield	electric	crimp	5	50	—
CX 03 P	pneumatic plastic Ø 1,6 - 3,0 - 4,0 mm	air	push-in	—	—	1
<b>+</b> CX 03 MP	pneumatic metal Ø 3,0 - 4,0 - 6,0 mm	air	push-in / quick-fitting	—	—	1
CX 02 P	pneumatic plastic Ø 6,0 mm	air	push-in	—	—	1
CX FM	none (dummy module)	—	—	—	—	1
CX 01 J8F/M/IM	RJ45	electric	crimp / IDC	—	—	1
CX 01 J8AIF/BIF/PIF	RJ45 + shield	electric	IDC	1	50	1
<b>+</b> CX 01 J8UM	RJ45	electric	IDC	—	—	1
CX 01 JF/M	RJ45 + auxiliary	electric	crimp	10	250	2
CX 02 JF/M	RJ45 + auxiliary	electric	crimp	10	250	3
CX 01 UF/M	USB	electric	—	—	—	1
CX 01 9VF/M	D-SUB	electric	crimp	5	50	1
CX 01 9VF2/M2	D-SUB + shield	electric	crimp	5	50	1
CX 01 9VTF	D-SUB	electric	screw	5	50	1
CX 01 MIF/MIM	HDMI	electric	—	—	—	1
CX 04 LF/M	POF / MOST	optic	crimp	—	—	1
CX 04 RF/M	coaxial	electric	crimp	—	—	1
CX 04 SCF/M	SC fibre optic	optic	crimp/glue	—	—	1



# TECHNICAL CHARACTERISTICS

- 1 Pneumatic contacts in metal (or plastic) with hose barb or quick-fitting connection.
- 2 Fibre optic contacts SC type.
- 3 Electric contacts in silver-plated or gold-plated brass with connections to the conductors via crimping, spring clamp or axial screw.
- 4 Modular inserts of identical size with insertion system for forming the complete module and frame lock tab.
- 5 Inserts in self-extinguishing thermoplastic material, reinforced with glass fibre, UL 94V-0 approved, with a working temperature range of -40 °C to +125 °C.
- 6 Inserts in conformance with the requirements of the EN 61984 standard and certified and marked with the UL, CSA, CQC, DNV-GL, BV, EAC marks.
- 7 Inserts with patented "swallowtails" to prevent incorrect coupling.
- 8 Position of contacts identified with numbers or codes on both sides of every insert.
- 9 Male/female module carrier frames with mandatory housings and polarity, in die-cast zinc alloy.
- 10 Module lock tab, may be divided according to the number of modules used; it guarantees a perfect stability of the modules during wiring and coupling/uncoupling of the connectors.
- 11 Asymmetric protective earth contacts (two per frame) with wide contact surface to prevent incorrect coupling; when two or more identical connectors of the MIXO series are used, coded pins may prevent incorrect coupling.
- 12 Captive frame fastening screws, with spring washer.
- 13 Dummy module for unused frame slots.

## ADVANTAGES

- ☑ Easy and user-friendly assembly of the complete multi-module insert before fixing it on the relevant sized metal frame;
- ☑ use of proprietary ILME technology providing each module with "swallowtails" (lateral keys/keyways), for reciprocal locking of modules and overall assembly of the insert into rigid (non hinged) frames with snap-in locking strips;
- ☑ faster and easier assembly compared with competitor solutions (easier handling of modules as a complete block than e.g. 6 independent parts);
- ☑ intermateability at "complete connector" (modules in frame) with other industry standard products;
- ☑ robust and long lasting prevailing crimp connection technology (largely preferred over screw type technology in high vibration and shock environments).

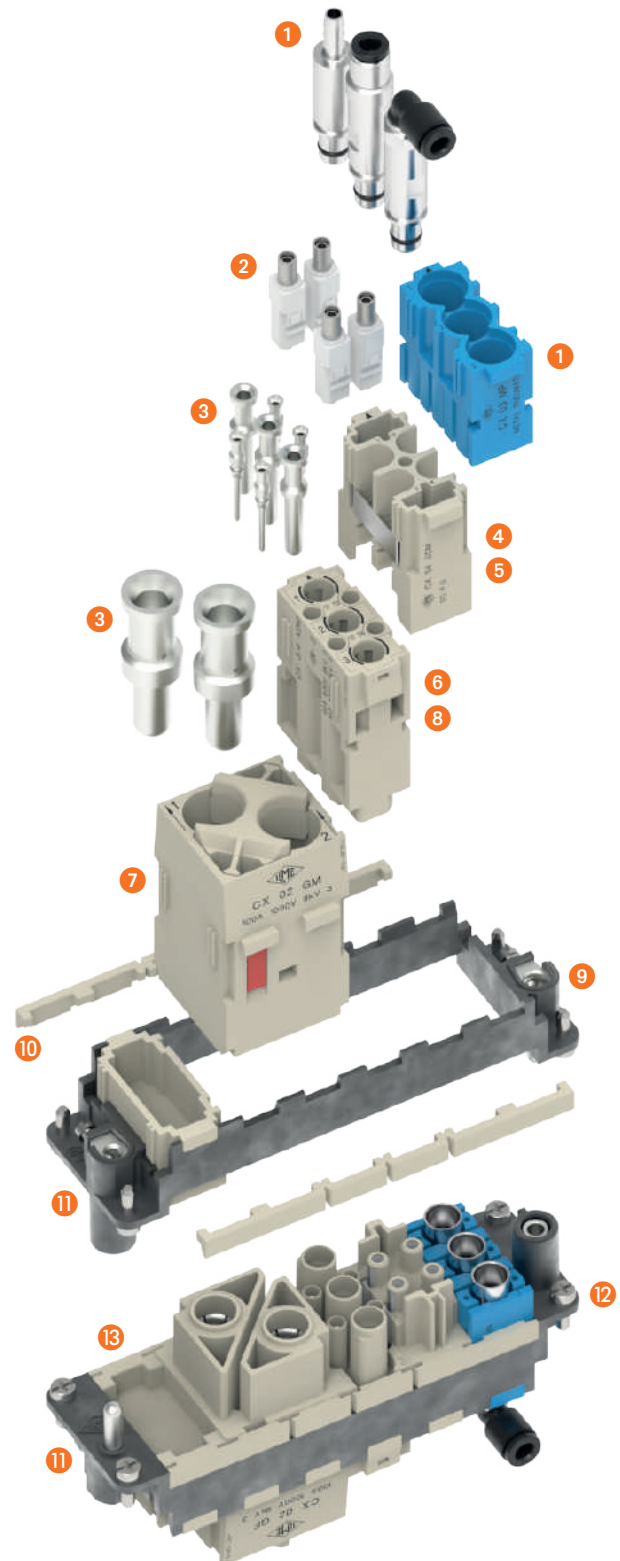

Watch our  
MIXO series  
video

## MIXO NOVELTIES

The MIXO series, featuring a flexible modular design for utmost versatile connector creation with easy and safe installation, is furtherly expanded, with the addition of 10 new modules (all single-sized, 2 completely new, 8 variants of existing ones for special applications), widening the MIXO portfolio to 63 modules, as follows:

- **CX 01 J8UM**  
**New MIXO RJ45 universal patch cord adapter**  
 single-sized, for 1 RJ45 male connector of a patch cord

46
- **CX 08 D5GF /D5GM and CX 08 D5GF2 /D5GM2**  
**New MIXO Megabit module with additional shield to PE (frame) bonding connection**  
 single-sized, 8 poles + shield, 10 A (crimp) – 50 V 0,8 kV 3  
 with relevant accessories

52
- **RX 08 D5GF /D5GM and RX 98 D5GF2 /D5GM2**  
**New MIXO HNM (High Number of Matings) Megabit module with additional shield to PE (frame) bonding connection**  
 single-sized, 8 poles + shield, 10 A (crimp) – 50 V 0,8 kV 3  
 for use with RD turned crimp HNM contacts in HNM MIXO frames

54
- **CX 08 I6GF /I6GM**  
**New MIXO Gigabit module with additional shield to PE (frame) bonding connection**  
 single-sized, 8 poles + shield, 5 A (crimp) – 50 V 0,8 kV 3  
 for use with CI turned crimp contacts

60
- **RX 08 I6GF /I6GM**  
**New MIXO HNM (High Number of Matings) Gigabit module with additional shield to PE (frame) bonding connection**  
 single-sized, 8 poles + shield, 5 A (crimp) – 50 V 0,8 kV 3  
 for use with RI HNM turned crimp contacts in HNM MIXO frames

62
- **CX 20S IGF /IGM**  
**New MIXO Shielded 4 A module with additional shield to PE (frame) bonding connection**  
 single-sized, 20 poles + shield, 4 A (crimp) – 32 V 0,8 kV 3  
 for use with CI turned crimp contacts

66
- **RX 20S IGF /IGM**  
**New MIXO HNM (High Number of Matings) Shielded module with additional shield to PE (frame) bonding connection**  
 single-sized, 20 poles + shield, 4 A (crimp) – 32 V 0,8 kV 3  
 for use with RI HNM turned crimp contacts in HNM MIXO frames

68
- **CX 03 MP**  
**New MIXO Pneumatic Metal module for New pneumatic metal contacts**  
 single-sized, 3 ways, for use with new pneumatic metal contacts **CX ... MPM /MPF /MPV /MPQM /MPQF /MPQV /MPAM /MPAF /MPAV**, up to 10 000 mating cycles  
 only in HNM MIXO frames (in standard MIXO frames up to 500 cycles)

72



Find more  
information on  
our products at  
[www.ilme.com](http://www.ilme.com)



## MIXO NOVELTIES ADVANTAGES

In addition to MIXO series advances at page 41, each of the new modules adds the following individual features:

- **universal RJ45 patch cord adapter in single-module size**, exports the "21.21" CJK 8UM universal RJ45 adapter concept to the MIXO world, enabling incorporation of off-the-shelf RJ45 patch cords of broader choice into a MIXO modular connector (CX 01 J8UM);

- **new variants** of the **Gigabit** module (8-way shielded module for high-speed shielded Gigabit Ethernet connection), the **Megabit** module (fully shielded connections for two 4-way data bus cables in a single-sized module – miniaturizing trend) and the **Shielded** module (20-pole shielded module) **with additional shield-to-PE (frame) bonding contacts** (two lateral spring clips on the shield), for applications demanding the lowest impedance of the earthing path at the expenses of separation of shielding from PE usually preferred to avoid "grounding loops" (MIXO Gigabit CX 08 IG6F/IG6M, MIXO Megabit CX 08 D5GF/D5GM and D5GF2/D5GM2, MIXO Shielded CX 20S IGF/IGM);

- **HNM versions with additional shield-to-PE (frame) bonding contacts** of the **Gigabit** module, the **Megabit** module and the **Shielded** module, for use when these modules are foreseen for frequent operation in combination with HNM MIXO frames RX ... TF/TM and HNM enclosures (MIXO Gigabit HNM RX 08 IG6F/IG6M, MIXO Megabit HNM RX 08 D5GF/D5GM and D5GF2/D5GM2, MIXO Shielded HNM RX 20S IGF/IGM);

- **increased versatility and improved robustness for pneumatic connections** when combined in pneumatic/electrical/data MIXO modular connectors, with the **new "pneumatic metal" module** and relevant **new pneumatic metal contacts**, the module holding up to 3 contacts also for the highest size Ø 6 mm (inner or outer diameter, depending on either hose barbs push-over connection or quick-fitting push-in connection) for straight connection and even with 90° angled connection, with or without shut-off valve, for compressed air with pressure up to 10 bar (CX 03 MP module, CX 3.0 /4.0 /6.0 MP...F/M metal pneumatic contacts).

## MIXO SERIES AT A GLANCE

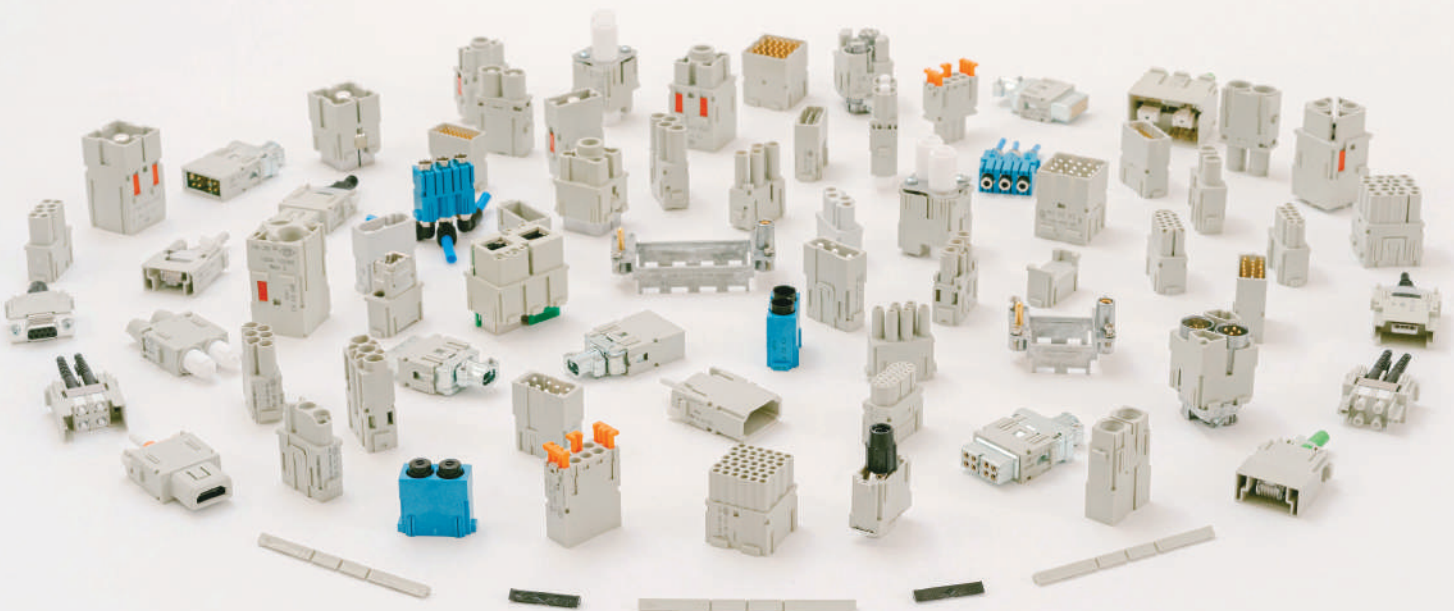

---

## MIXO RJ45 UNIVERSAL PATCH CORD ADAPTER CX 01 J8UM

---

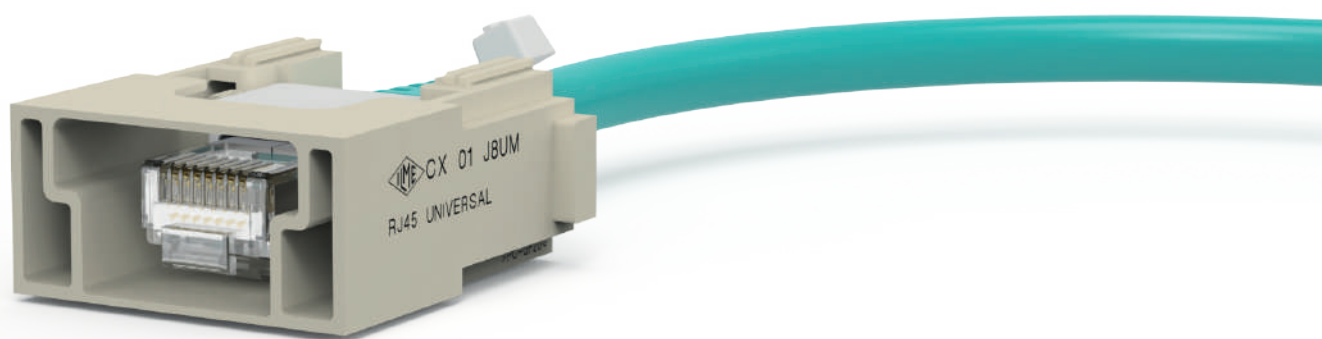

MIXO Module  
RJ45 male patch cord  
universal adapter



Find more  
information on  
our products at  
[www.ilme.com](http://www.ilme.com)

## TECHNICAL FEATURES

### CX 01 J8UM



Watch  
our technical  
clip

Extending the current offer of male patch cord or plug adapters:

- **CX 01 J8M** for crimp type **CX 8 J6M** RJ45 Cat. 6<sub>A</sub> plug connector or CW ... J2M87 patch cord, and
- **CX 01 J8IM**, for IDC type **CX 8 J6IM** RJ45 Cat. 6 plug connector,

mating with

- **CX 01 J8F** RJ45 Cat. 6<sub>A</sub> female/female coupler, or
- **CX 01 J8AIF / CX 01 J8BIF / CX 01 J8PIF** RJ45 Cat. 6<sub>A</sub> female/IDC connector,

the new male module adapter **CX 01 J8UM** is suitable to lock in place RJ45 plugs of patch cords with maximum overall dimensions 13,5 mm x 9,5 mm on the shell, 34 mm max length (see drawing on page 48).

NOTE – International Standard IEC 60603-7 covering RJ45 interface standardizes only the mating face and latch, and the connector performance, leaving the shell dimensions free.

Suitable for mating on counterpart F/F module adapter **CX 01 J8F** or any of the **CX 01 J8xIF** (x = A, B or P) presenting an RJ45 Cat. 6<sub>A</sub> jack (female) connector on both the mating side and the cable side, to accept suitable patch cord.

snap-in,  
releasable,  
plastic latch for  
securing the plug  
and cable tie  
for strain relief

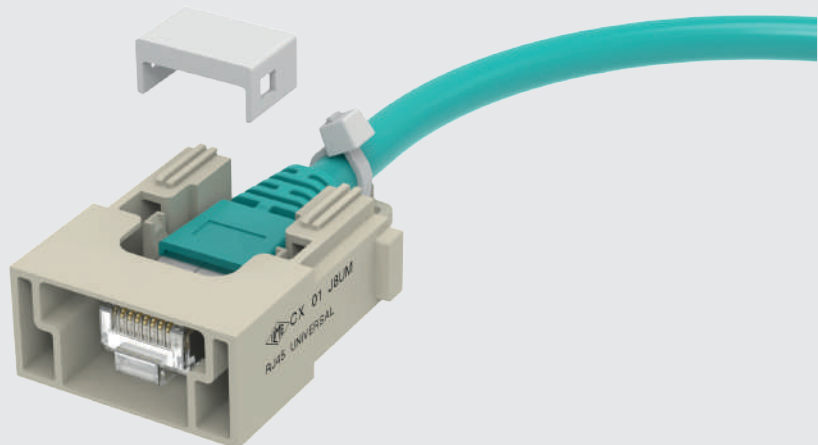

# CX 01 J8UM RJ45 universal patch cord adapter

The modular inserts must be installed in suitable frames which are then mounted in traditional housings or in COB panel support. Single-sized modular units may be directly mounted inside MIXO ONE enclosures.

## RJ45 universal patch cord adapter

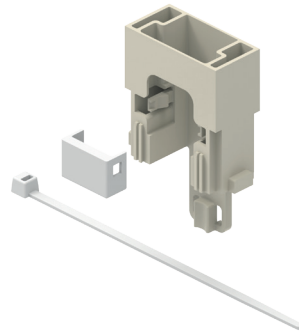

page:

frames for modular units

76

MIXO ONE enclosures

369

refer to CN.19 pages

description

part No.

RJ45 universal patch cord adapter

CX 01 J8UM

- UL, DNV-GL, BV pending
- insulation resistance:  $\geq 10 \text{ G}\Omega$
- ambient temperature limit:  $-40 \text{ }^\circ\text{C} \dots +125 \text{ }^\circ\text{C}$
- made of self-extinguishing thermoplastic resin UL 94V-0

### CX 01 J8UM

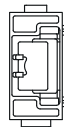
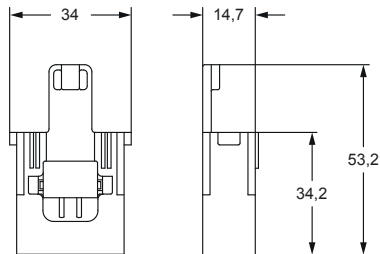

- 1 frame slot

### CW PATCH CORD RJ45

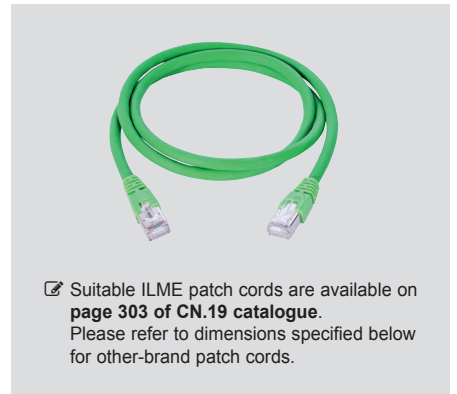

Suitable ILME patch cords are available on page 303 of CN.19 catalogue. Please refer to dimensions specified below for other-brand patch cords.

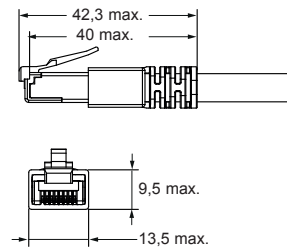

## ASSEMBLY INSTRUCTIONS

### CX 01 J8UM - RJ45 UNIVERSAL PATCH CORD CONNECTION

1

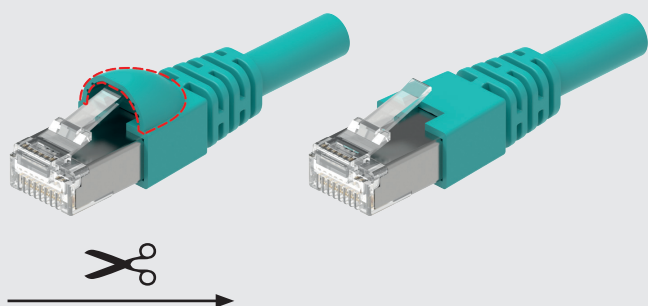
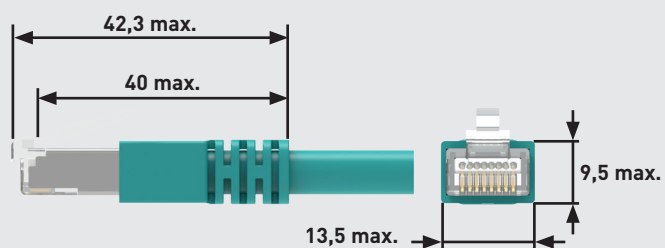

2

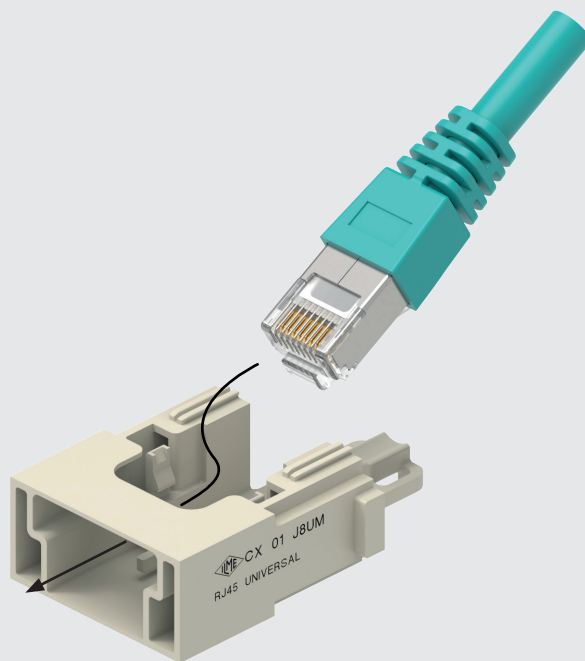

3

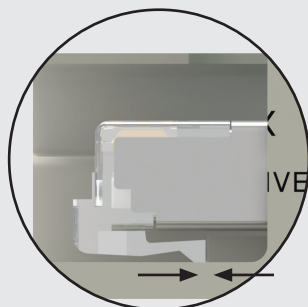
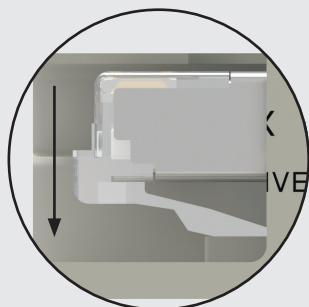
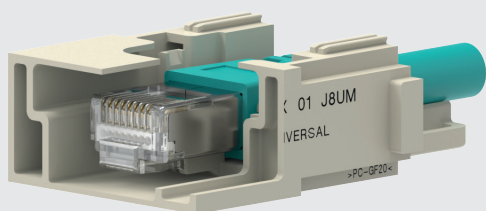

4

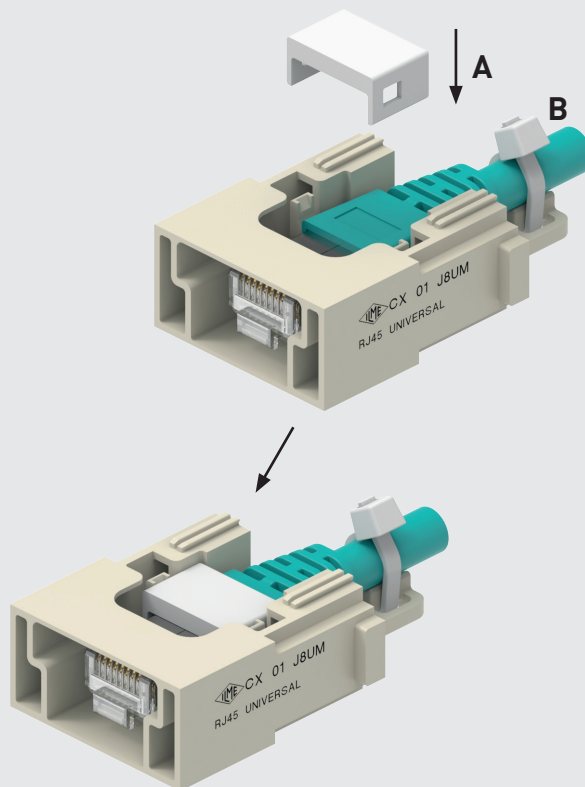

---

MIXO MEGABIT - GIGABIT - SHIELDED  
WITH ADDITIONAL SHIELD BONDING CONTACTS  
TO THE MIXO FRAME

---

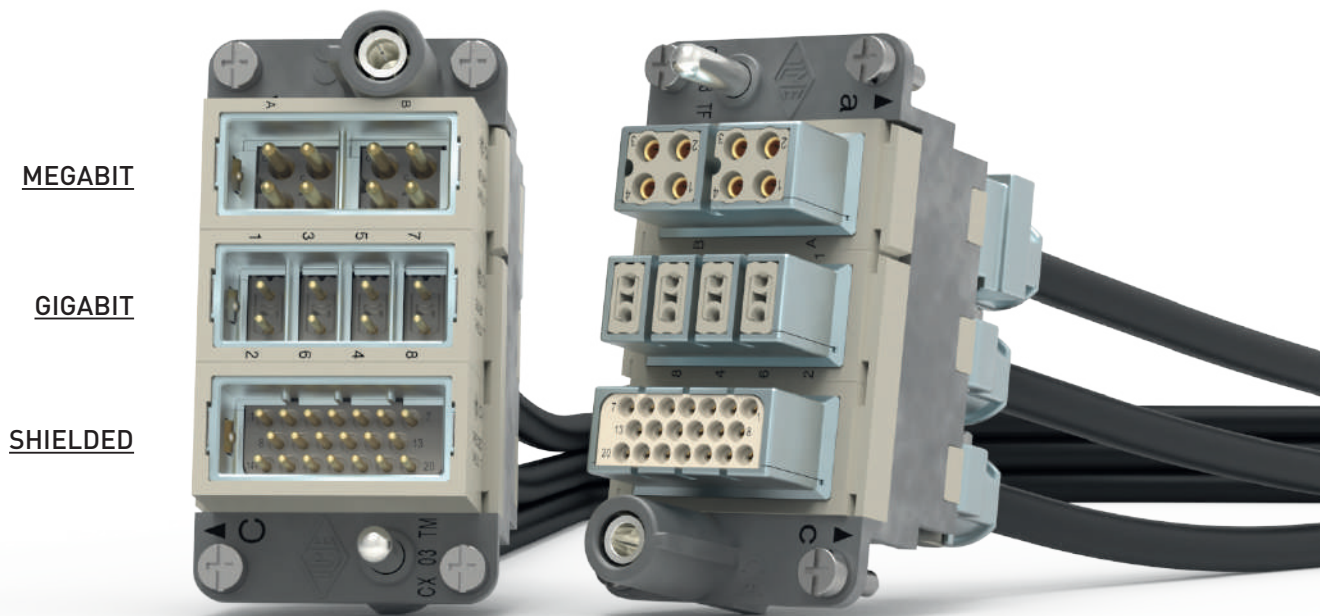

MIXO DATA  
MEGABIT - GIGABIT - SHIELDED  
STANDARD and HNM version



Find more  
information on  
our products at  
[www.ilme.com](http://www.ilme.com)



## TECHNICAL FEATURES

### MEGABIT

**CX 08 D5GF/GM /D5GF2/GM2**

**RX 08 D5GF/GM /D5GF2/GM2**

### SHIELDED

**CX 20S IGF /IGM**

**RX 20S IGF /IGM**

### GIGABIT

**CX 08 I6GF /I6GM**

**RX 08 I6GF /I6GM**

All these three data connector modules (**Gigabit, Megabit, Shielded**) and their three HNM versions, sharing the same shield, are now made available also in **new versions including two additional side contacts on the shield**, consisting of riveted stainless steel springs in correspondence of the MIXO metal frame, so as to realize equipotential bonding between the shield (and the connected screen of the incoming data cable(s) and the PE potential established by the relevant PE terminal(s) on the MIXO frame.

The part numbers identifying these new models are built from those of standard versions by adding letter G as for “grounding” in the suffix before the letter identifying its gender.

E.g.: CX 08 D5F becomes CX 08 D5GF

Whereas it is common practice to keep separate the shielding potential of a data line from that of the PE protective earthing, in order not to establish ground loops that could yield undesired interference on the signals shielded by the cable screen and the connector shield, in special applications, e.g. in railway rolling stock, the motto is *“the higher the number of bonding contacts, the better”* as the “Earth” zero volt reference relies only upon multiple parallel touch contacts between the rail and the wheels on all bogies of the entire train, and these “contacts” are definitely not permanent, being continuously “rolling”.

The feature now available through these new versions of already existing MIXO Gigabit, MIXO Megabit, and MIXO Shielded modules, satisfies such special need for more common, shared “grounding”. Each connector module in this new version maintains the same characteristics of the corresponding standard version without additional shield bonding contacts.

<b>MIXO Megabit</b>	<b>CX 08 D5GF /D5GM</b>	single cable entry/clamp	
	<b>CX 08 D5GF2 /D5GM2</b>	double cable entry/clamp	
<b>HNM version</b>	<b>RX 08 D5GF /D5GM</b>	single cable entry/clamp	For up to 10 000 operating cycles with series <b>RD HNM</b> crimp contacts and HNM MIXO frames <b>RX ... TF /TM</b>
	<b>RX 08 D5GF2 / D5GM2</b>	double cable entry/clamp	
<b>MIXO Gigabit</b>	<b>CX 08 I6GF /I6GM</b>		
<b>HNM version</b>	<b>RX 08 I6GF /I6GM</b>		For up to 10 000 operating cycles with series <b>RI HNM</b> crimp contacts and HNM MIXO frames <b>RX ... TF /TM</b>
<b>MIXO Shielded</b>	<b>CX 20S IGF /IGM</b>		
<b>HNM version</b>	<b>RX 20S IGF /IGM</b>		For up to 10 000 operating cycles with series <b>RI HNM</b> crimp contacts and HNM MIXO frames <b>RX ... TF /TM</b>

**additional PE contacts (both sides) via spring to MIXO frame**

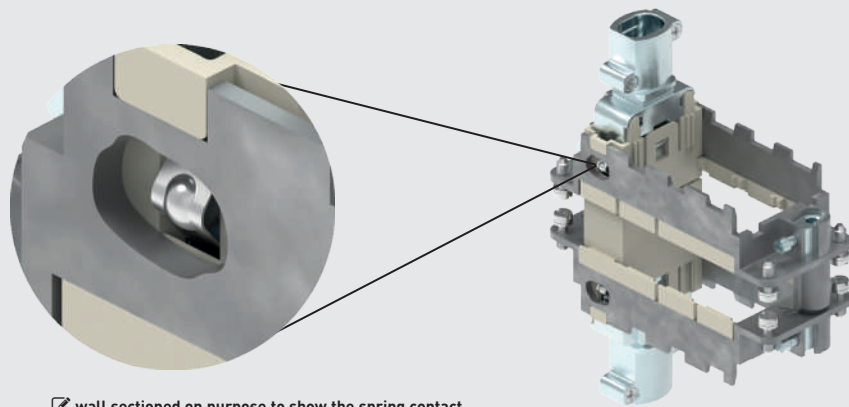

☑ wall sectioned on purpose to show the spring contact riveted on each side of the shield

# Megabit 8 poles + shield bonding connection 10 A - 50 V

The modular inserts must be installed in suitable frames which are then mounted in traditional housings or in COB panel support. Single-sized modular units may be directly mounted inside MIXO ONE enclosures.

modular units,  
crimp connection  
single cable entry

modular units,  
crimp connection  
double cable entry

	page:
frames for modular units	76
MIXO ONE enclosures	369

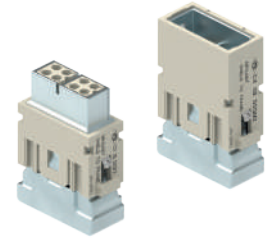
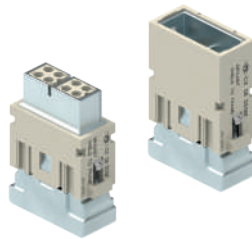

refer to CN.19 pages

description	part No.	part No.
-------------	----------	----------

without contacts (to be ordered separately)  
female inserts for female contacts  
male inserts for male contacts

**CX 08 D5GF**  
**CX 08 D5GM**

without contacts (to be ordered separately)  
female inserts for female contacts  
male inserts for male contacts

**CX 08 D5GF2**  
**CX 08 D5GM2**

- characteristics according to EN/IEC 61984 ratings:  
**10 A 50 V 0,8 kV 3**
- cUL (UL for USA and Canada), CSA, CQC, DNV-GL, BV pending
- rated voltage according to UL/CSA: 50 V
- insulation resistance:  $\geq 10 \text{ G}\Omega$
- ambient temperature limit:  $-40 \text{ }^\circ\text{C} \dots +85 \text{ }^\circ\text{C}$
- fully shielded connector module for data transmission, Megabit Ethernet Category 5e (5 in the code), Class D, frequencies up to 100 MHz, data rate up to 100 Mbit/s
- made of self-extinguishing thermoplastic resin UL 94V-0
- shield made by zinc-alloy
- mechanical life:  $\geq 500$  cycles
- contact resistance:  $\leq 3 \text{ m}\Omega$
- **it is recommended to crimp the contacts with crimping tools homologated by ILME** (please see the crimping tool section 10 A contacts CDF, CDM series pages 708 - 741 of CN.19 catalogue).  
For 10 A contacts CDF, CDM series, see also the new pneumatic crimping tool CCPZP RN (see NEWS 2020 page 145).

**CX 08 D5GF, CX 08 D5GM**

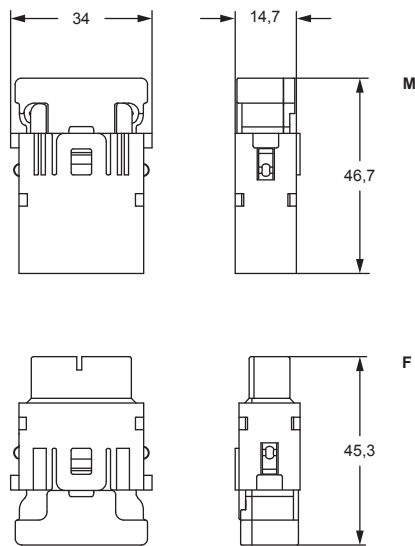

**CX 08 D5GF2, CX 08 D5GM2**

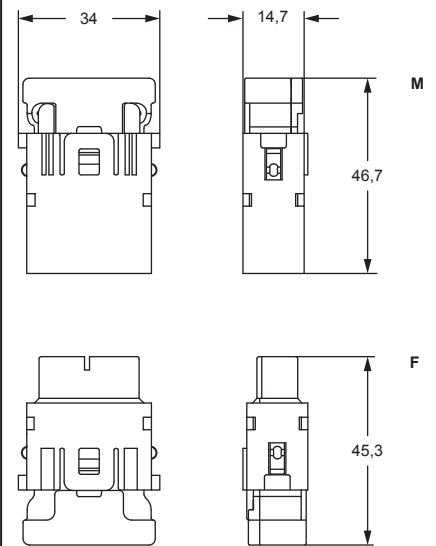

we recommend the use of CRF / CRM coding pins together with relevant MIXO frame

contacts side (front view)

side with reference arrow ▲

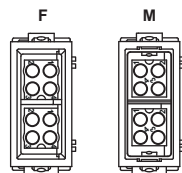

- 1 frame slot

contacts side (front view)

side with reference arrow ▲

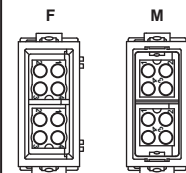

- 1 frame slot



# CX...CA Cable clamp - CD 10 A Crimp contacts

## cable clamp



## CD (10 A) crimp contacts gold plated



description	part No.	part No.
cable clamp for 5-7 mm cable diameter	<b>CX 5/7 CA</b>	
cable clamp for 7-10 mm cable diameter	<b>CX 7/10 CA</b>	
cable clamp for 10-12 mm cable diameter <sup>1)</sup>	<b>CX 10/12 CA</b>	
<b>10 A female contacts</b>		
0,14-0,37 mm <sup>2</sup> AWG 26-22 identification No. 1		<b>CDFD 0.3</b>
0,5 mm <sup>2</sup> AWG 20 identification No. 2		<b>CDFD 0.5</b>
0,75 mm <sup>2</sup> AWG 18 identification No. ②		<b>CDFD 0.7</b>
1 mm <sup>2</sup> AWG 18 identification No. 3		<b>CDFD 1.0</b>
1,5 mm <sup>2</sup> AWG 16 identification No. 4		<b>CDFD 1.5</b>
2,5 mm <sup>2</sup> AWG 14 identification No. 5		<b>CDFD 2.5</b>
<b>10 A male contacts</b>		
0,14-0,37 mm <sup>2</sup> AWG 26-22 identification No. 1		<b>CDMD 0.3</b>
0,5 mm <sup>2</sup> AWG 20 identification No. 2		<b>CDMD 0.5</b>
0,75 mm <sup>2</sup> AWG 18 identification No. ②		<b>CDMD 0.7</b>
1 mm <sup>2</sup> AWG 18 identification No. 3		<b>CDMD 1.0</b>
1,5 mm <sup>2</sup> AWG 16 identification No. 4		<b>CDMD 1.5</b>
2,5 mm <sup>2</sup> AWG 14 identification No. 5		<b>CDMD 2.5</b>

gold plated<sup>†</sup>

<sup>1)</sup> only for single cable entry modules

☞ Upon request we can supply crimp flange and crimp sleeves of different diameters that must be chosen according to the specific cable shield and insulation diameter, please contact ILME Commercial Offices.

crimp flange

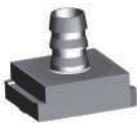

crimp sleeves



### CX 5/7 CA, CX 7/10 CA, CX 10/12 CA

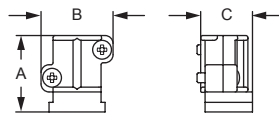

part No.	A	B	C
<b>CX 5/7 CA</b>	19,1	18	12,95
<b>CX 7/10 CA</b>	19,1	18	12,95
<b>CX 10/12 CA</b>	19,1	20,8	12,95

<sup>†</sup> for basic or high thickness gold plating, please refer to page 674 of CN.19 catalogue

### CDF and CDM

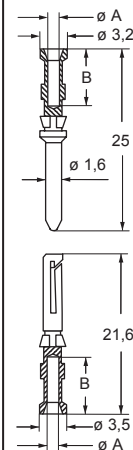

### CDF and CDM contacts

conductor section mm <sup>2</sup>	conductor slot ø A (mm)	conductors stripping length B (mm)
0,14-0,37	0,9	8
0,5	1,1	8
0,75	1,3	8
1,0	1,45	8
1,5	1,8	8
2,5	2,2	6

**Megabit 8 poles + shield bonding connection 10 A - 50 V HNM (High Number of Matings)**

The modular inserts must be installed in suitable frames which are then mounted in HNM enclosures.

modular units,  
crimp connection  
single cable entry

modular units,  
crimp connection  
double cable entry

page:  
frames for modular units 77

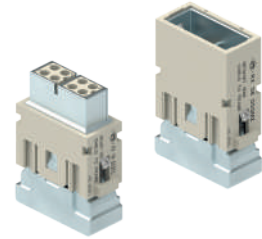
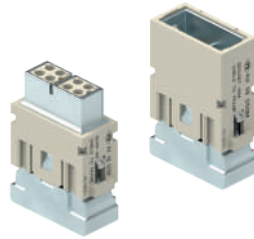

**Q 10 000 MATINGS WITH HNM FRAMES AND HNM ENCLOSURES**

**Q 10 000 MATINGS WITH HNM FRAMES AND HNM ENCLOSURES**

description

part No.

part No.

without contacts (to be ordered separately)  
female inserts for female contacts  
male inserts for male contacts

**RX 08 D5GF  
RX 08 D5GM**

without contacts (to be ordered separately)  
female inserts for female contacts  
male inserts for male contacts

**RX 08 D5GF2  
RX 08 D5GM2**

- characteristics according to EN/IEC 61984 ratings:  
**10 A 50 V 0,8 kV 3**
- cUL (UL for USA and Canada), CSA, CQC, DNV-GL, BV pending
- rated voltage according to UL/CSA: 50 V
- insulation resistance:  $\geq 10 \text{ G}\Omega$
- ambient temperature limit:  $-40 \text{ }^\circ\text{C} \dots +85 \text{ }^\circ\text{C}$
- fully shielded connector module for data transmission, Megabit Ethernet Category 5e (5 in the code), Class D, frequencies up to 100 MHz, data rate up to 100 Mbit/s
- made of self-extinguishing thermoplastic resin UL 94V-0
- shield made by zinc-alloy
- mechanical life:  $\geq 10.000$  cycles
- contact resistance:  $\leq 3 \text{ m}\Omega$
- **it is recommended to crimp the contacts with crimping tools homologated by ILME** (please see the crimping tool section 10 A contacts RDF2D, RDM2D series, pages 708 - 741 of CN.19 catalogue). For 10 A contacts RDF2D, RDM2D series, see also the new pneumatic crimping tool CCPZP RN (see NEWS 2020 page 145).

**RX 08 D5GF, RX 08 D5GM**

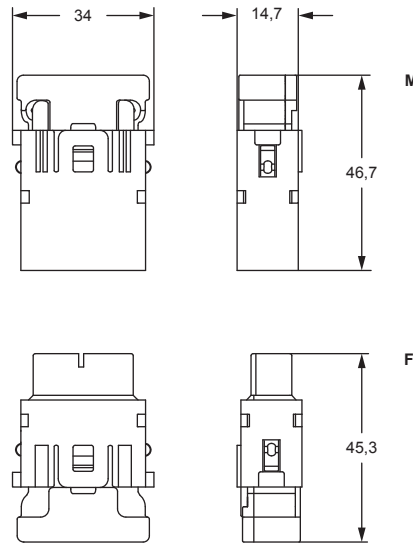

**RX 08 D5GF2, RX 08 D5GM2**

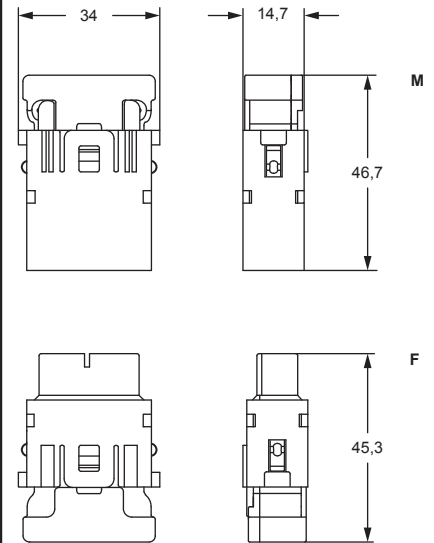

we recommend the use of CRF / CRM coding pins together with relevant MIXO frame

contacts side (front view)

contacts side (front view)

side with reference arrow ▲

side with reference arrow ▲

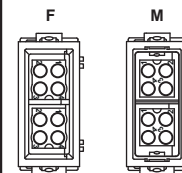
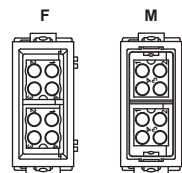

- 1 frame slot

- 1 frame slot

# CX...CA Cable clamp - HNM RD 2D 10 A Crimp contacts

cable clamp



RD 2D (10 A) crimp contacts  
gold plated



description	part No.	part No.
cable clamp for 5-7 mm cable diameter	<b>CX 5/7 CA</b>	
cable clamp for 7-10 mm cable diameter	<b>CX 7/10 CA</b>	
cable clamp for 10-12 mm cable diameter <sup>1)</sup>	<b>CX 10/12 CA</b>	
<b>10 A female contacts</b>		
0,14-0,37 mm <sup>2</sup> AWG 26-22 identification No. 1		<b>RDF2D 0.3</b>
0,5 mm <sup>2</sup> AWG 20 identification No. 2		<b>RDF2D 0.5</b>
0,75 mm <sup>2</sup> AWG 18 identification No. ②		<b>RDF2D 0.7</b>
1 mm <sup>2</sup> AWG 18 identification No. 3		<b>RDF2D 1.0</b>
1,5 mm <sup>2</sup> AWG 16 identification No. 4		<b>RDF2D 1.5</b>
2,5 mm <sup>2</sup> AWG 14 identification No. 5		<b>RDF2D 2.5</b>
<b>10 A male contacts</b>		
0,14-0,37 mm <sup>2</sup> AWG 26-22 identification No. 1		<b>RDM2D 0.3</b>
0,5 mm <sup>2</sup> AWG 20 identification No. 2		<b>RDM2D 0.5</b>
0,75 mm <sup>2</sup> AWG 18 identification No. ②		<b>RDM2D 0.7</b>
1 mm <sup>2</sup> AWG 18 identification No. 3		<b>RDM2D 1.0</b>
1,5 mm <sup>2</sup> AWG 16 identification No. 4		<b>RDM2D 1.5</b>
2,5 mm <sup>2</sup> AWG 14 identification No. 5		<b>RDM2D 2.5</b>

gold plated

<sup>1)</sup> only for single cable entry modules

☞ Upon request we can supply crimp flange and crimp sleeves of different diameters that must be chosen according to the specific cable shield and insulation diameter, please contact ILME Commercial Offices.

crimp flange

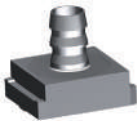

crimp sleeves



CX 5/7 CA, CX 7/10 CA, CX 10/12 CA

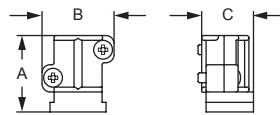

part No.	A	B	C
<b>CX 5/7 CA</b>	19,1	18	12,95
<b>CX 7/10 CA</b>	19,1	18	12,95
<b>CX 10/12 CA</b>	19,1	20,8	12,95

RDF2D and RDM2D

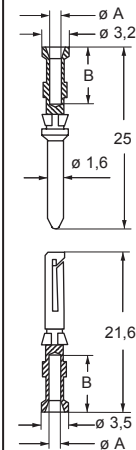

**RDF2D and RDM2D contacts**

conductor section mm <sup>2</sup>	conductor slot ø A (mm)	conductors stripping length B (mm)
0,14-0,37	0,9	8
0,5	1,1	8
0,75	1,3	8
1,0	1,45	8
1,5	1,8	8
2,5	2,2	6

# Megabit 8 poles + shield 10 A - 50 V

## ASSEMBLY INSTRUCTIONS

### MIXO MEGABIT "SINGLE CABLE ENTRY" CX 08 D5GF OR RX 08 D5GF (HNM)

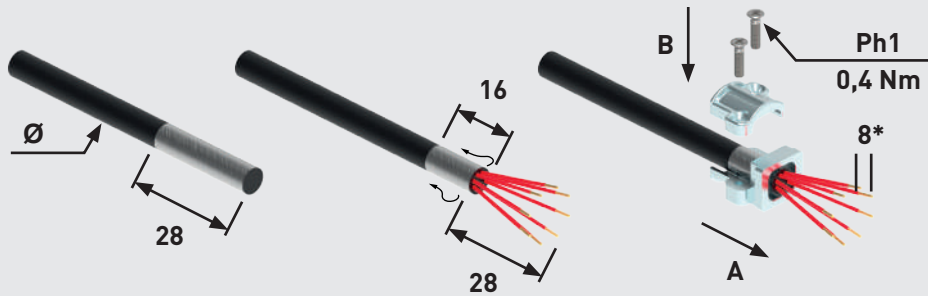

Cable clamp part No.	mm	Screw size	Tightening torque (Nm)	Recommended size of screwdriver
CX 5/7 CA	5-7	M 2,5	0,4	Ph1
CX 7/10 CA	7-10	M 2,5	0,4	Ph1
CX 10/12 CA	10-12	M 2,5	0,4	Ph1

\* 6 mm for CD and RD ... 2.5

1

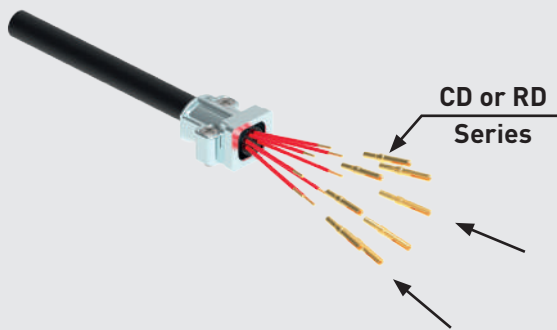

2

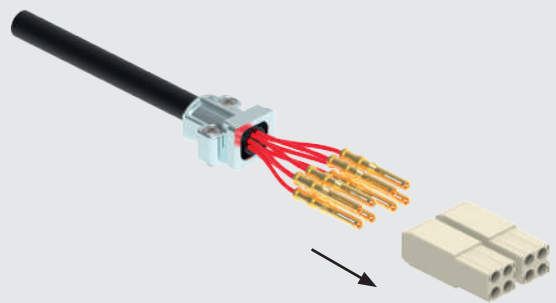

3

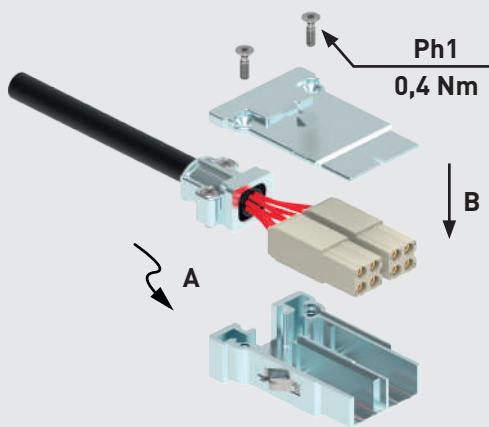

4

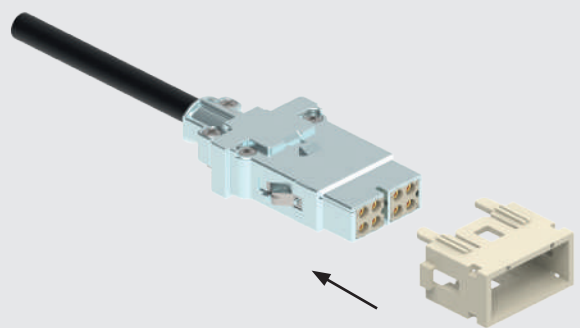

5

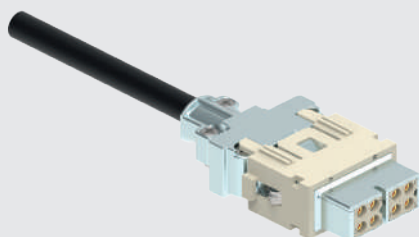

CX 08 D5GF or RX 08 D5GF (HNM)

# ASSEMBLY INSTRUCTIONS

## MIXO MEGABIT "SINGLE CABLE ENTRY" CX 08 D5GM OR RX 08 D5GM (HNM)

Watch our assembly tutorial

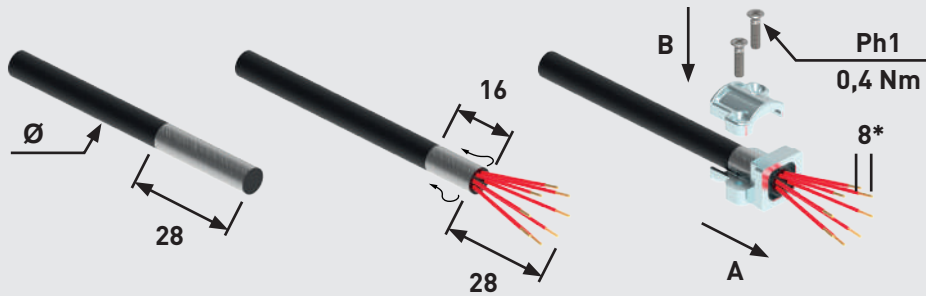

Cable clamp part No.	mm	Screw size	Tightening torque (Nm)	Recommended size of screwdriver
CX 5/7 CA	5-7	M 2,5	0,4	Ph1
CX 7/10 CA	7-10	M 2,5	0,4	Ph1
CX 10/12 CA	10-12	M 2,5	0,4	Ph1

\* 6 mm for CD and RD ... 2.5

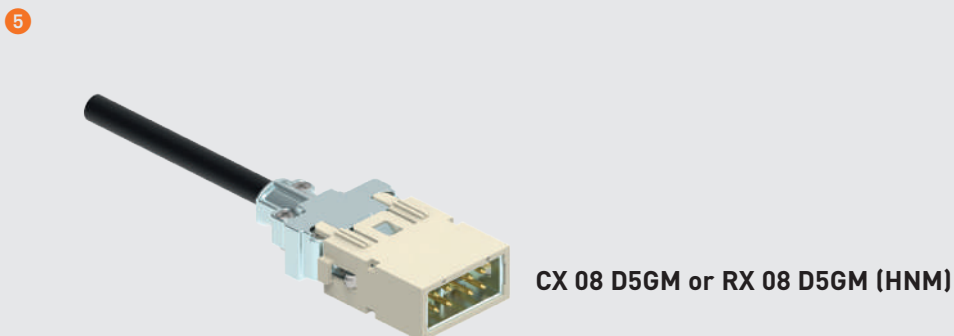
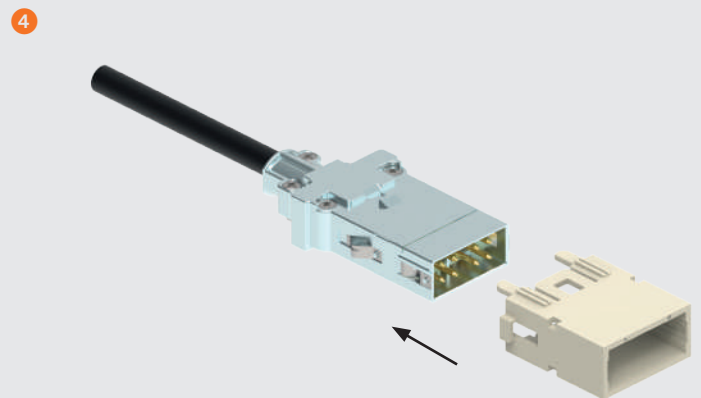
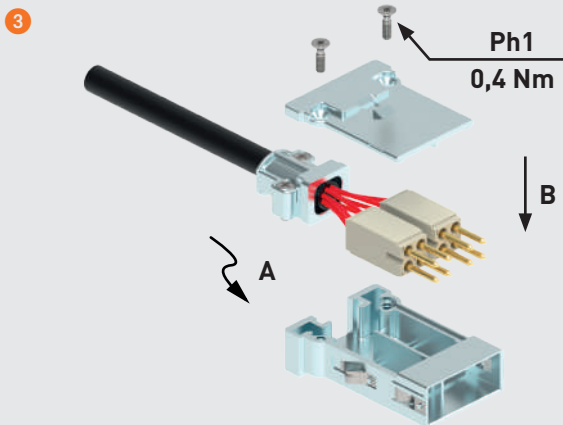
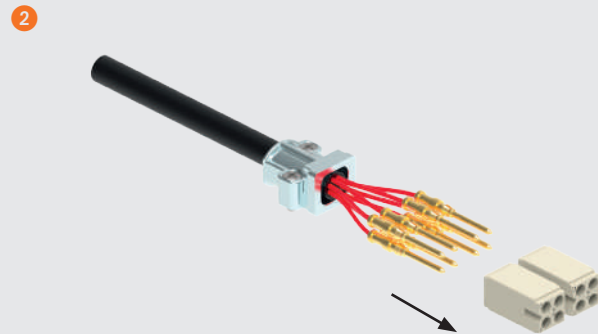
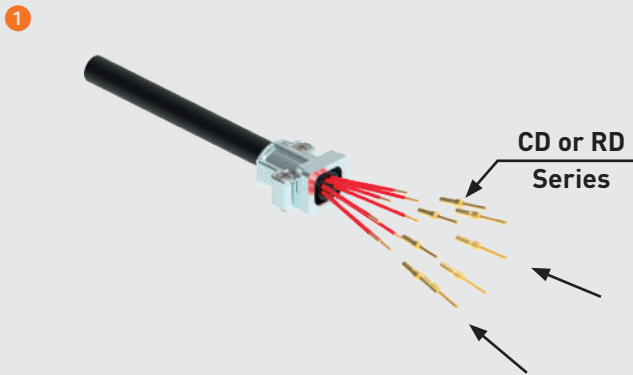

# Megabit 8 poles + shield 10 A - 50 V

## ASSEMBLY INSTRUCTIONS

### MIXO MEGABIT "DOUBLE CABLE ENTRY" CX 08 D5GF2 OR RX 08 D5GF2 (HNM)

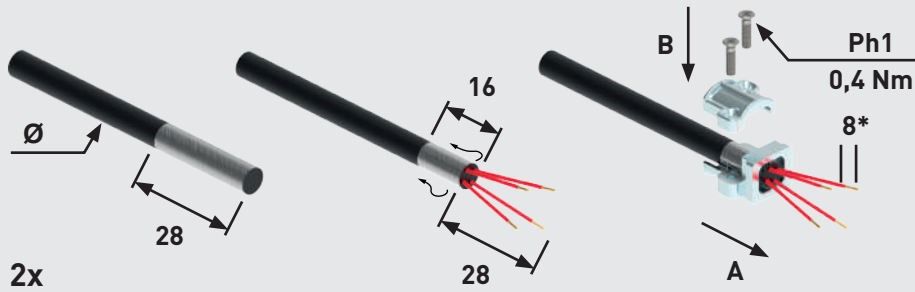

Cable clamp part No.	Ø mm	Screw size	Tightening torque (Nm)	Recommended size of screwdriver
CX 5/7 CA	5-7	M 2,5	0,4	Ph1
CX 7/10 CA	7-10	M 2,5	0,4	Ph1

\* 6 mm for CD and RD... 2.5

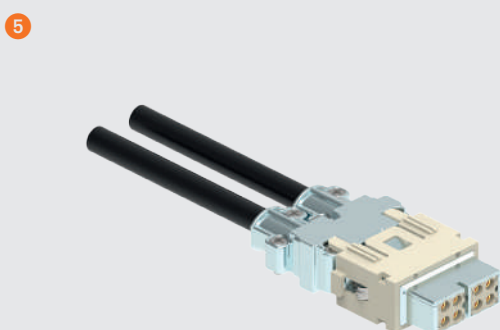
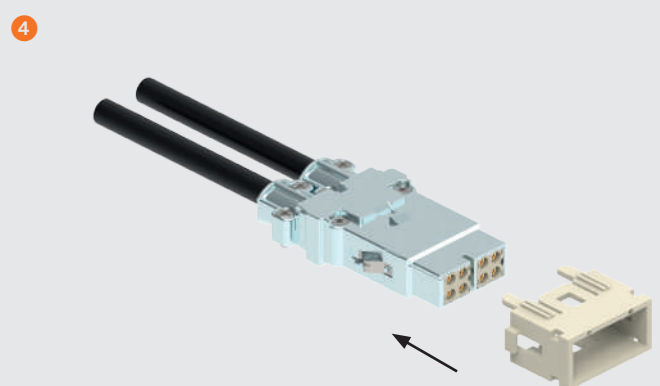
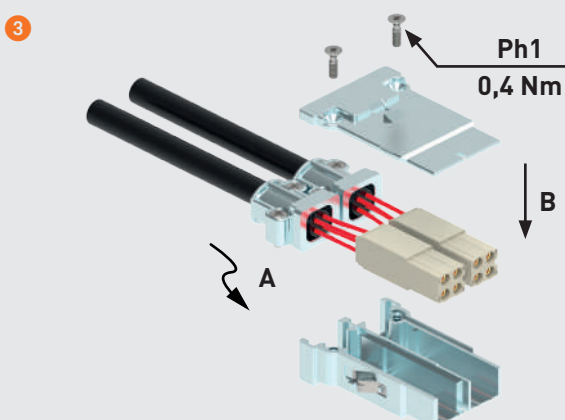
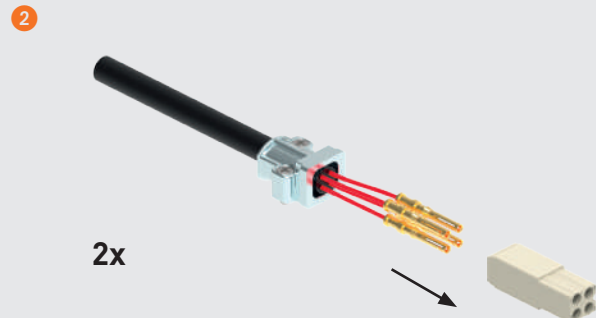
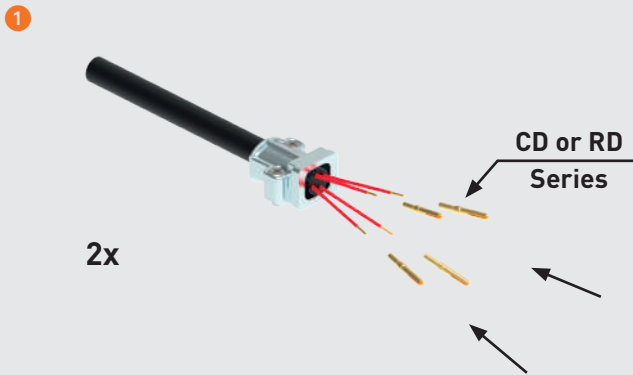

CX 08 D5GF2 or RX 08 D5GF2 (HNM)

# ASSEMBLY INSTRUCTIONS

## MIXO MEGABIT "DOUBLE CABLE ENTRY" CX 08 D5GM2 OR RX 08 D5GM2 (HNM)

Watch our assembly tutorial

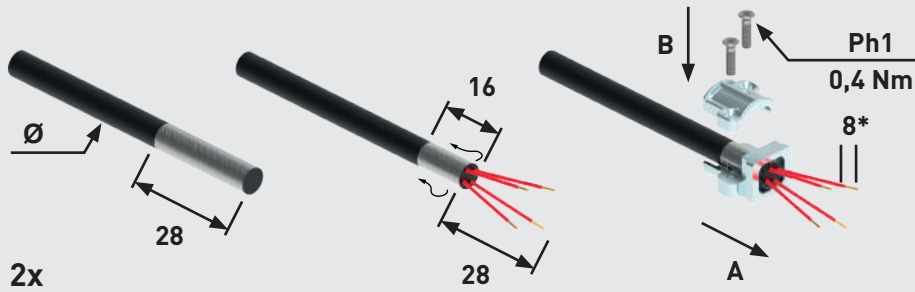

Cable clamp part No.	∅ mm	Screw size	Tightening torque (Nm)	Recommended size of screwdriver
CX 5/7 CA	5-7	M 2,5	0,4	Ph1
CX 7/10 CA	7-10	M 2,5	0,4	Ph1

\* 6 mm for CD and RD... 2.5

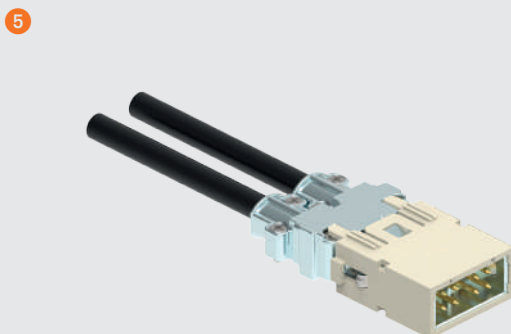
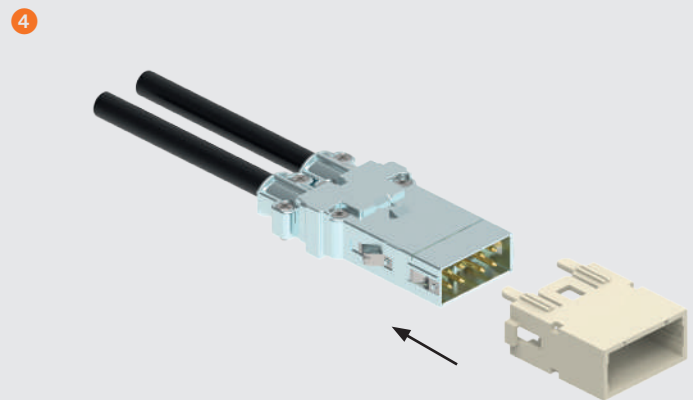
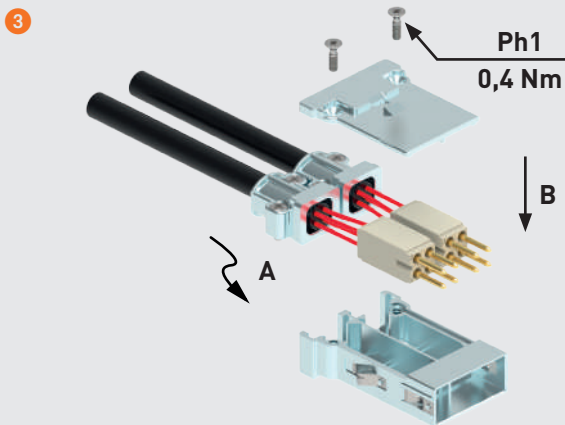
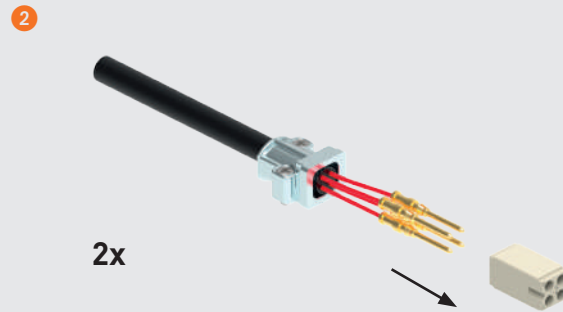
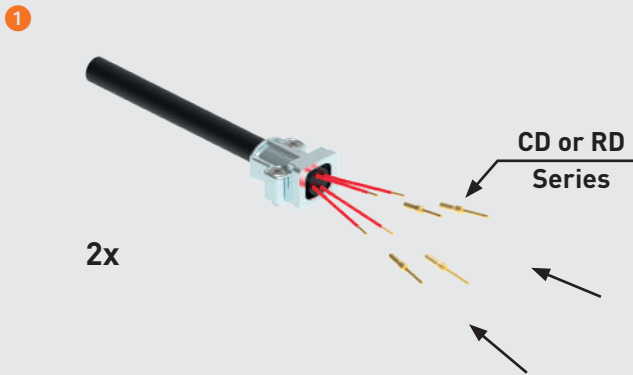

CX 08 D5GM2 or RX 08 D5GM2 (HNM)

# Gigabit 8 poles + shield connection 5 A - 50 V

The modular inserts must be installed in suitable frames which are then mounted in traditional enclosures\* or in COB panel support.

page:

frames for modular units\*

76

\* enclosures: bulkhead mounting housings, high construction housings or high construction hoods

refer to CN.19 pages

modular units,  
crimp connection

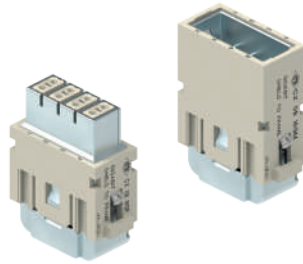

cable clamp



description	part No.	part No.
without contacts (to be ordered separately) female inserts for female contacts male inserts for male contacts	<b>CX 08 I6GF</b> <b>CX 08 I6GM</b>	
cable clamp for 5-7 mm cable diameter cable clamp for 7-10 mm cable diameter cable clamp for 10-12 mm cable diameter cable clamp for 11-14 mm cable diameter		<b>CX 5/7 CA</b> <b>CX 7/10 CA</b> <b>CX 10/12 CA</b> <b>CX 11/14 CA</b>

- characteristics according to EN/IEC 61984 ratings:  
**5 A 50 V 0,8 kV 3**

- UL, CSA, CQC, DNV-GL, BV pending
- rated voltage according to UL/CSA: 50 V
- insulation resistance:  $\geq 10 \text{ G}\Omega$
- ambient temperature limit:  $-40 \text{ }^\circ\text{C} \dots +85 \text{ }^\circ\text{C}$
- suitable for bus signals, in particular for Ethernet Cat. 6A (Gigabit)
- made of self-extinguishing thermoplastic resin UL 94V-0
- mechanical life:  $\geq 500$  cycles
- contact resistance:  $\leq 4 \text{ m}\Omega$
- for crimp contacts CI series use:

- CIPZ D** crimping tool
- CIPZP D** pneumatic crimping tool (see NEWS 2020 page 144)
- CITP D** turret head
- CIES** insertion / removal tool for contacts 0,2 - 0,5 mm<sup>2</sup> (see pages 716 - 719 of CN.19 catalogue)

we recommend the use of CRF / CRM coding pins together with relevant MIXO frame

Upon request we can supply crimp flange and crimp sleeves of different diameters that must be chosen according to the specific cable shield and insulation diameter, please contact ILME Commercial Offices.

crimp  
flange

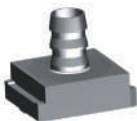

crimp  
sleeves



**CX 08 I6GF, CX 08 I6GM**

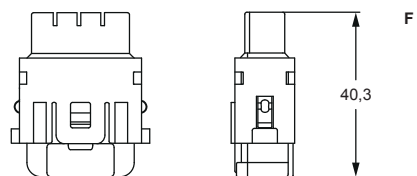
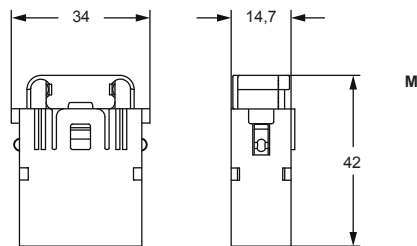

contacts side (front view)

side with reference arrow ▲

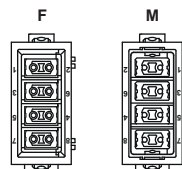

- 1 frame slot

**CX 5/7 CA, CX 7/10 CA, CX 10/12 CA**

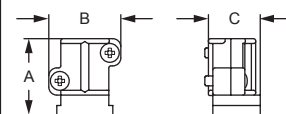

part No.	A	B	C
<b>CX 5/7 CA</b>	19,1	18	12,95
<b>CX 7/10 CA</b>	19,1	18	12,95
<b>CX 10/12 CA</b>	19,1	20,8	12,95

**CX 11/14 CA**

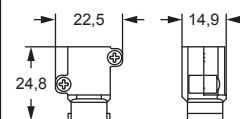



# CI 5 A Crimp contacts

## CI (5 A) crimp contacts gold plated



description	part No.
CI (5 A) female crimp contacts 0,08-0,21 mm <sup>2</sup> AWG 28-24 0,13-0,33 mm <sup>2</sup> AWG 26-22 0,33-0,52 mm <sup>2</sup> AWG 22-20	<b>CIFD 0.2</b> <b>CIFD 0.3</b> <b>CIFD 0.5</b>
CI (5 A) male crimp contacts 0,08-0,21 mm <sup>2</sup> AWG 28-24 0,13-0,33 mm <sup>2</sup> AWG 26-22 0,33-0,52 mm <sup>2</sup> AWG 22-20	<b>CIMD 0.2</b> <b>CIMD 0.3</b> <b>CIMD 0.5</b>

gold plated<sup>+</sup>

<sup>+</sup> for basic or high thickness gold plating, please refer to page 74 of NEWS 2020 catalogue

### CIF and CIM

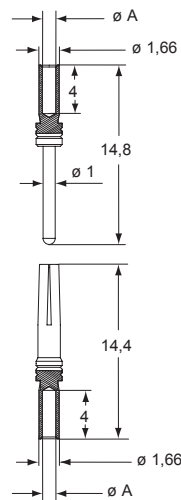

### CIF and CIM contacts

conductor section (mm <sup>2</sup> )	conductor slot $\varnothing A$ (mm)	conductors stripping length (mm)
0,08-0,21	0,64	4
0,13-0,33	0,90	4
0,33-0,52	1,12	4

The modular inserts must be installed in suitable frames which are then mounted in HNM enclosures.

page:

frames for modular units\*

77

\* enclosures: bulkhead mounting housings, high construction housings or high construction hoods

modular units,  
crimp connections

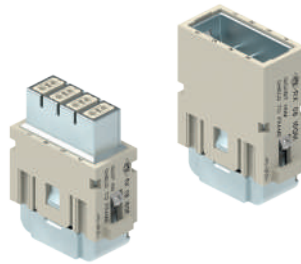

**Q 10 000 MATINGS WITH HNM FRAMES AND HNM ENCLOSURES**

cable clamp



description	part No.	part No.
-------------	----------	----------

without contacts (to be ordered separately)  
female inserts for female contacts  
male inserts for male contacts

**RX 08 I6GF**  
**RX 08 I6GM**

cable clamp for 5-7 mm cable diameter  
cable clamp for 7-10 mm cable diameter  
cable clamp for 10-12 mm cable diameter  
cable clamp for 11-14 mm cable diameter

**CX 5/7 CA**  
**CX 7/10 CA**  
**CX 10/12 CA**  
**CX 11/14 CA**

- characteristics according to EN/IEC 61984 ratings:  
**5 A 50 V 0,8 kV 3**

- UL, CSA, CQC, DNV-GL, BV pending
- rated voltage according to UL/CSA: 50 V
- insulation resistance:  $\geq 10 \text{ G}\Omega$
- ambient temperature limit:  $-40 \text{ }^\circ\text{C} \dots +85 \text{ }^\circ\text{C}$
- suitable for bus signals, in particular for Ethernet Cat. 6A (Gigabit)
- made of self-extinguishing thermoplastic resin UL 94V-0
- mechanical life:  $\geq 10.000$  cycles
- contact resistance:  $\leq 4 \text{ m}\Omega$
- for crimp contacts RI series use:

- CIPZ D** crimping tool
- CIPZP D** pneumatic crimping tool (see NEWS 2020 page 144)
- CITP D** turret head
- CIES** insertion / removal tool for contacts 0,2 - 0,5 mm<sup>2</sup> (see pages 716 - 719 of CN.19 catalogue)

we recommend the use of CRF / CRM coding pins together with relevant MIXO frame

Upon request we can supply crimp flange and crimp sleeves of different diameters that must be chosen according to the specific cable shield and insulation diameter, please contact ILME Commercial Offices.

crimp flange



crimp sleeves



**RX 08 I6GF, RX 08 I6GM**

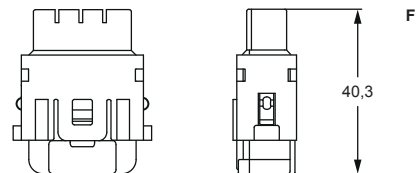
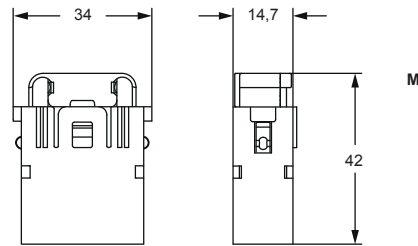

contacts side (front view)

side with reference arrow ▲

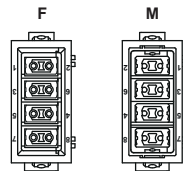

- 1 frame slot

**CX 5/7 CA, CX 7/10 CA, CX 10/12 CA**

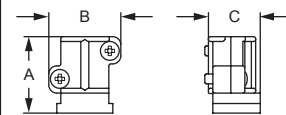

part No.	A	B	C
<b>CX 5/7 CA</b>	19,1	18	12,95
<b>CX 7/10 CA</b>	19,1	18	12,95
<b>CX 10/12 CA</b>	19,1	20,8	12,95

**CX 11/14 CA**

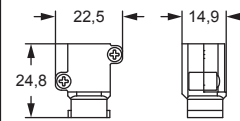

# RI 5 A Crimp contacts

## RI (5 A) crimp contacts gold plated



description

part No.

RI (5 A) female crimp contacts  
 0,08-0,21 mm<sup>2</sup> AWG 28-24  
 0,13-0,33 mm<sup>2</sup> AWG 26-22  
 0,33-0,52 mm<sup>2</sup> AWG 22-20

RIFD 0.2  
 RIFD 0.3  
 RIFD 0.5

gold plated

RI (5 A) male crimp contacts  
 0,08-0,21 mm<sup>2</sup> AWG 28-24  
 0,13-0,33 mm<sup>2</sup> AWG 26-22  
 0,33-0,52 mm<sup>2</sup> AWG 22-20

RIMD 0.2  
 RIMD 0.3  
 RIMD 0.5

### RIF and RIM

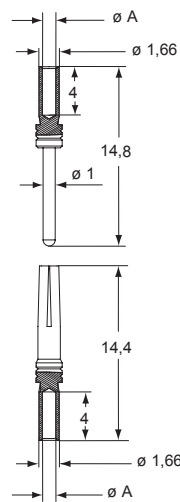

### RIF and RIM contacts

conductor section (mm <sup>2</sup> )	conductor slot $\varnothing A$ (mm)	conductors stripping length (mm)
0,08-0,21	0,64	4
0,13-0,33	0,90	4
0,33-0,52	1,12	4

# Gigabit 8 poles + shield 5 A - 50 V

## ASSEMBLY INSTRUCTIONS

### MIXO GIGABIT CX 08 I6GF OR RX 08 I6GF (HNM) - FEMALE MODULE

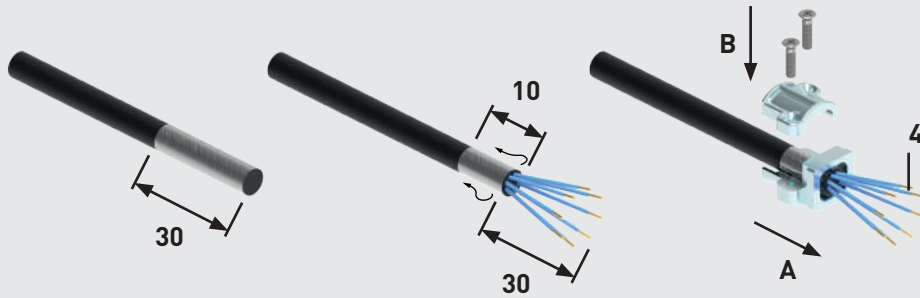

Cable clamp part No.	mm	Screw size	Tightening torque (Nm)	Recommended size of screwdriver
CX 5/7 CA	5-7	M 2,5	0,4	Ph1
CX 7/10 CA	7-10	M 2,5	0,4	Ph1
CX 10/12 CA	10-12	M 2,5	0,4	Ph1
CX 11/14 CA	11-14	M 2,5	0,4	Ph1

1

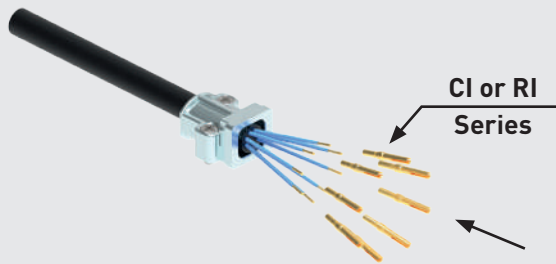

2

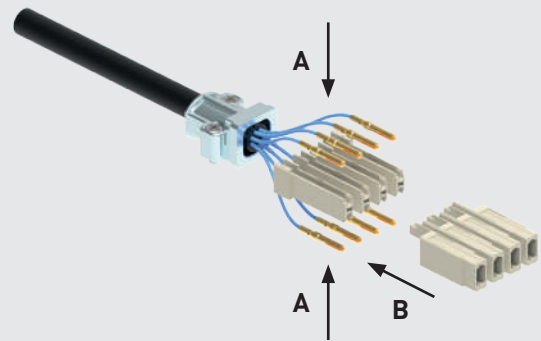

3

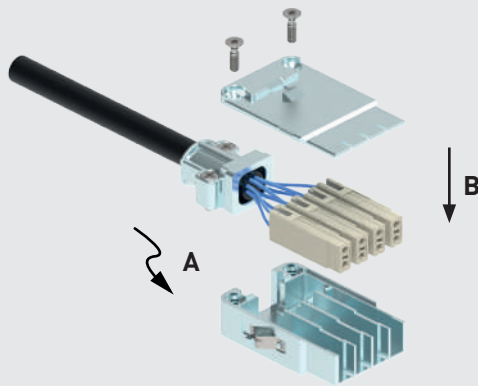

4

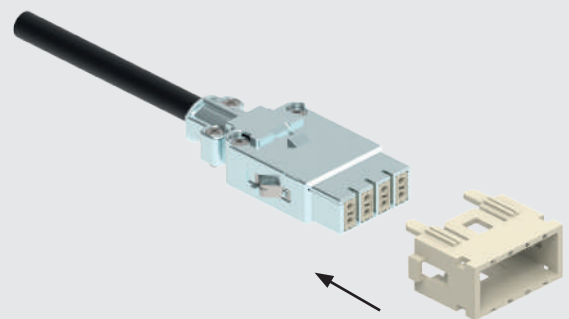

5

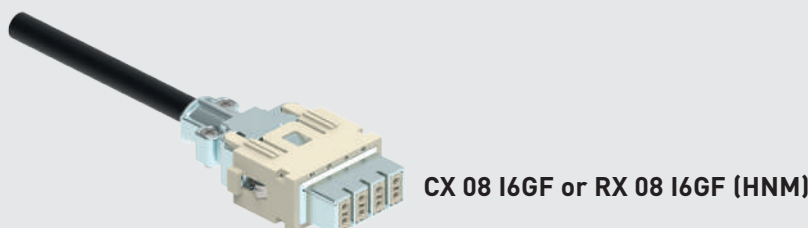

# ASSEMBLY INSTRUCTIONS

## MIXO GIGABIT CX 08 I6GM OR RX 08 I6GM (HNM) - MALE MODULE

Watch our assembly tutorial

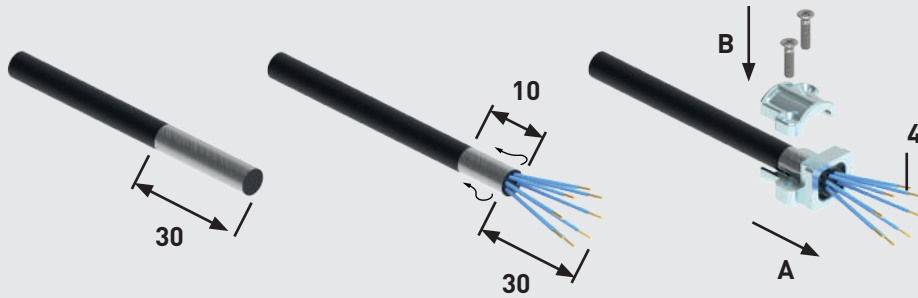

Cable clamp part No.	mm ∅	Screw size	Tightening torque (Nm)	Recommended size of screwdriver
CX 5/7 CA	5-7	M 2,5	0,4	Ph1
CX 7/10 CA	7-10	M 2,5	0,4	Ph1
CX 10/12 CA	10-12	M 2,5	0,4	Ph1
CX 11/14 CA	11-14	M 2,5	0,4	Ph1

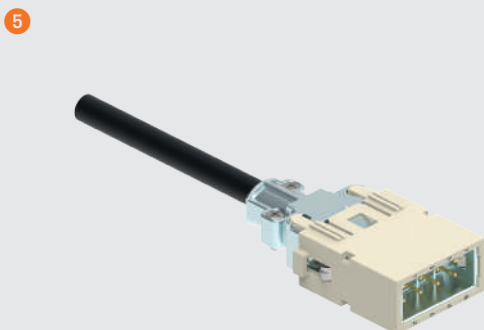
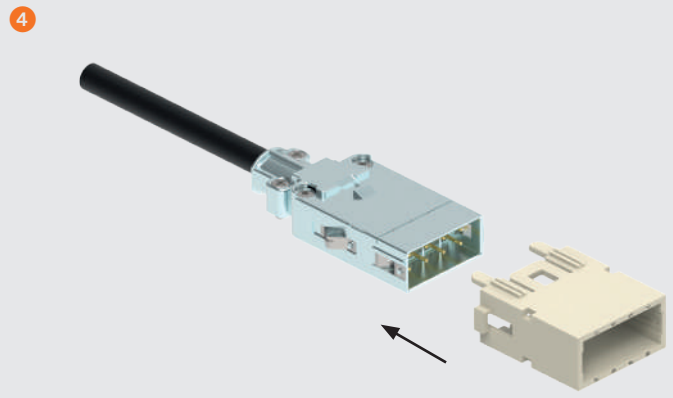
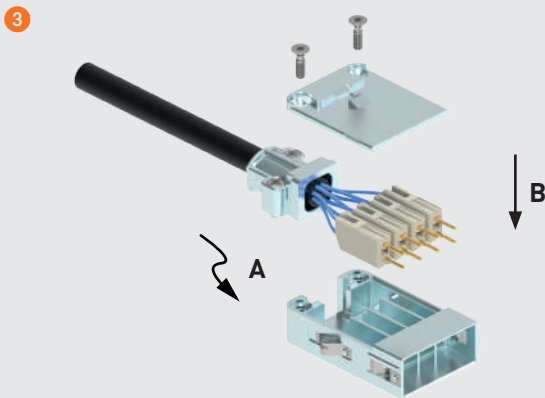
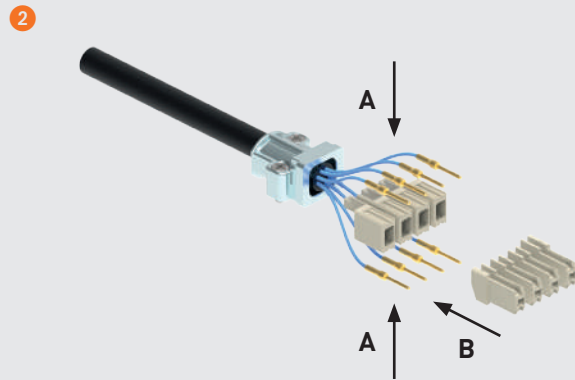
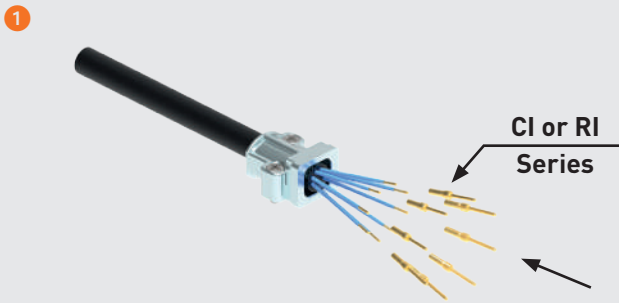

**CX 08 I6GM or RX 08 I6GM (HNM)**

# Shielded 20 poles + shield connection 4 A - 32 V

The modular inserts must be installed in suitable frames which are then mounted in traditional housings or in COB panel support.

page:

frames for modular units

76

refer to CN.19 pages

modular units,  
crimp connection

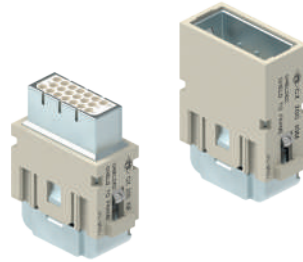

cable clamp



description	part No.	part No.
-------------	----------	----------

without contacts (to be ordered separately)  
female inserts for female contacts  
male inserts for male contacts

**CX 20S IGF**  
**CX 20S IGM**

cable clamp for 5-7 mm cable diameter  
cable clamp for 7-10 mm cable diameter  
cable clamp for 10-12 mm cable diameter  
cable clamp for 11-14 mm cable diameter

**CX 5/7 CA**  
**CX 7/10 CA**  
**CX 10/12 CA**  
**CX 11/14 CA**

- characteristics according to EN/IEC 61984 ratings:  
**4 A 32 V 0,8 kV 3**
- UL, CSA, CQC, DNV-GL, BV pending
- rated voltage according to UL/CSA: 32 V
- insulation resistance:  $\geq 10 \text{ G}\Omega$
- Lower and Upper Limiting Temperatures (LLT ... ULT):  
-40 °C ... +85 °C
- made of self-extinguishing thermoplastic resin  
UL 94V-0
- mechanical life:  $\geq 500$  cycles
- contact resistance:  $\leq 4 \text{ m}\Omega$
- for crimp contacts CI series use:  
**CIPZ D** crimping tool  
**CIPZP D** pneumatic crimping tool (see NEWS 2020  
page 144)  
**CITP D** turret head  
(see pages 716 - 719 of CN.19 catalogue)
- for max. current load see the connector inserts derating  
diagrams **under construction**.

we recommend the use of CRF / CRM coding pins  
together with relevant MIXO frame

Upon request we can supply crimp flange and crimp  
sleeves of different diameters that must be chosen  
according to the specific cable shield and insulation  
diameter, please contact ILME Commercial Offices.

crimp  
flange

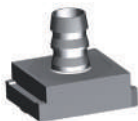

crimp  
sleeves



**CX 20S IGF, CX 20S IGM**

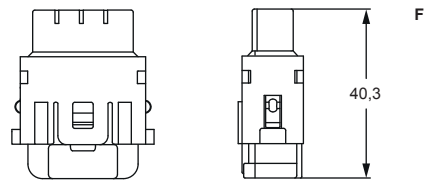
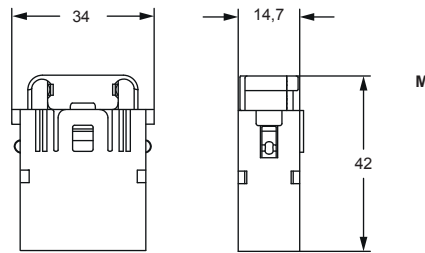

contacts side (front view)

side with reference arrow ▲

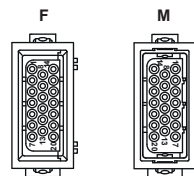

- 1 frame slot

**CX 5/7 CA, CX 7/10 CA, CX 10/12 CA**

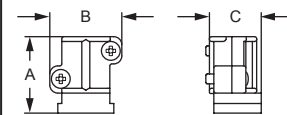

part No.	A	B	C
<b>CX 5/7 CA</b>	19,1	18	12,95
<b>CX 7/10 CA</b>	19,1	18	12,95
<b>CX 10/12 CA</b>	19,1	20,8	12,95

**CX 11/14 CA**

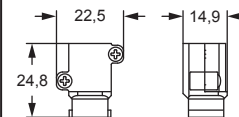

# CI 4 A Crimp contacts

## CI (4 A) crimp contacts gold plated



description	part No.
<b>CI (4 A) female crimp contacts</b> 0,08-0,21 mm <sup>2</sup> AWG 28-24 0,13-0,33 mm <sup>2</sup> AWG 26-22 0,33-0,52 mm <sup>2</sup> AWG 22-20	<b>CIFD 0.2</b> <b>CIFD 0.3</b> <b>CIFD 0.5</b>
<b>CI (4 A) male crimp contacts</b> 0,08-0,21 mm <sup>2</sup> AWG 28-24 0,13-0,33 mm <sup>2</sup> AWG 26-22 0,33-0,52 mm <sup>2</sup> AWG 22-20	<b>CIMD 0.2</b> <b>CIMD 0.3</b> <b>CIMD 0.5</b>

gold plated<sup>+</sup>

<sup>+</sup> for basic or high thickness gold plating, please refer to page 74 of NEWS 2020 catalogue

### CIF and CIM

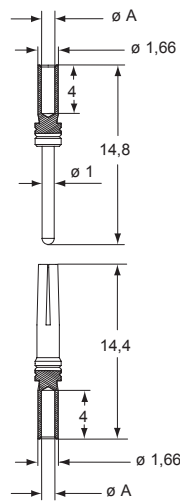

### CIF and CIM contacts

conductor section (mm <sup>2</sup> )	conductor slot ø A (mm)	conductors stripping length (mm)
0,08-0,21	0,64	4
0,13-0,33	0,90	4
0,33-0,52	1,12	4

# Shielded 20 poles + shield connection 4 A - 32 V HNM (High Number of Matings)

The modular inserts must be installed in suitable frames which are then mounted in HNM enclosures.

page:

frames for modular units\*

77

\* enclosures: bulkhead mounting housings, high construction housings or high construction hoods

modular units,  
crimp connections

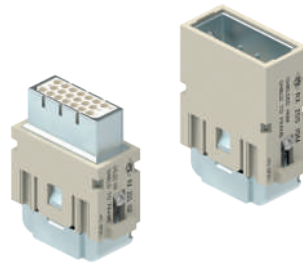

**Q 10 000 MATINGS WITH HNM FRAMES AND HNM ENCLOSURES**

cable clamp



description	part No.	part No.
-------------	----------	----------

without contacts (to be ordered separately)  
female inserts for female contacts  
male inserts for male contacts

**RX 20S IGF**  
**RX 20S IGM**

cable clamp for 5-7 mm cable diameter  
cable clamp for 7-10 mm cable diameter  
cable clamp for 10-12 mm cable diameter  
cable clamp for 11-14 mm cable diameter

**CX 5/7 CA**  
**CX 7/10 CA**  
**CX 10/12 CA**  
**CX 11/14 CA**

- characteristics according to EN/IEC 61984 ratings:  
**4 A 32 V 0,8 kV 3**
- UL, CSA, CQC, DNV-GL, BV pending
- rated voltage according to UL/CSA: 32 V
- insulation resistance:  $\geq 10 \text{ G}\Omega$
- Lower and Upper Limiting Temperatures (LLT ... ULT):  
-40 °C ... +85 °C
- made of self-extinguishing thermoplastic resin  
UL 94V-0
- mechanical life:  $\geq 10.000$  cycles
- contact resistance:  $\leq 4 \text{ m}\Omega$
- for crimp contacts RI series use:  
**CIPZ D** crimping tool  
**CIPZP D** pneumatic crimping tool (see NEWS 2020 page 144)  
**CITP D** turret head  
(see pages 716 - 719 of CN.19 catalogue)
- for max. current load see the connector inserts derating diagrams **under construction**.

we recommend the use of CRF / CRM coding pins together with relevant MIXO frame

Upon request we can supply crimp flange and crimp sleeves of different diameters that must be chosen according to the specific cable shield and insulation diameter, please contact ILME Commercial Offices.

crimp  
flange

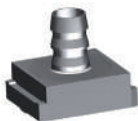

crimp  
sleeves



**RX 20S IGF, RX 20S IGM**

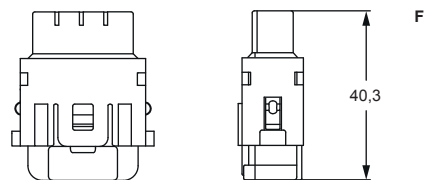
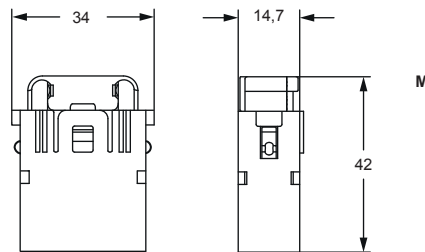

contacts side (front view)

side with reference arrow ▲

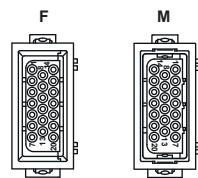

- 1 frame slot

**CX 5/7 CA, CX 7/10 CA, CX 10/12 CA**

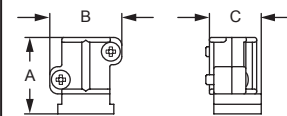

part No.	A	B	C
<b>CX 5/7 CA</b>	19,1	18	12,95
<b>CX 7/10 CA</b>	19,1	18	12,95
<b>CX 10/12 CA</b>	19,1	20,8	12,95

**CX 11/14 CA**

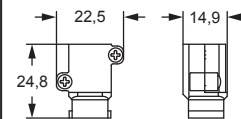



# RI 4 A Crimp contacts

## RI (4 A) crimp contacts gold plated



description

part No.

RI (4 A) female crimp contacts  
 0,08-0,21 mm<sup>2</sup> AWG 28-24  
 0,13-0,33 mm<sup>2</sup> AWG 26-22  
 0,33-0,52 mm<sup>2</sup> AWG 22-20

RIFD 0.2  
 RIFD 0.3  
 RIFD 0.5

gold plated

RI (4 A) male crimp contacts  
 0,08-0,21 mm<sup>2</sup> AWG 28-24  
 0,13-0,33 mm<sup>2</sup> AWG 26-22  
 0,33-0,52 mm<sup>2</sup> AWG 22-20

RIMD 0.2  
 RIMD 0.3  
 RIMD 0.5

### RIF and RIM

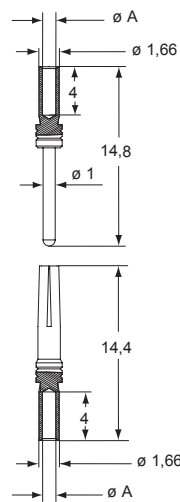

### RIF and RIM contacts

conductor section (mm <sup>2</sup> )	conductor slot $\varnothing A$ (mm)	conductors stripping length (mm)
0,08-0,21	0,64	4
0,13-0,33	0,90	4
0,33-0,52	1,12	4

# MIXO Shielded 20 poles + shield 4 A - 32 V

## ASSEMBLY INSTRUCTIONS

### MIXO SHIELDED CX 20S IGF OR RX 20S IGF (HNM) - FEMALE MODULE

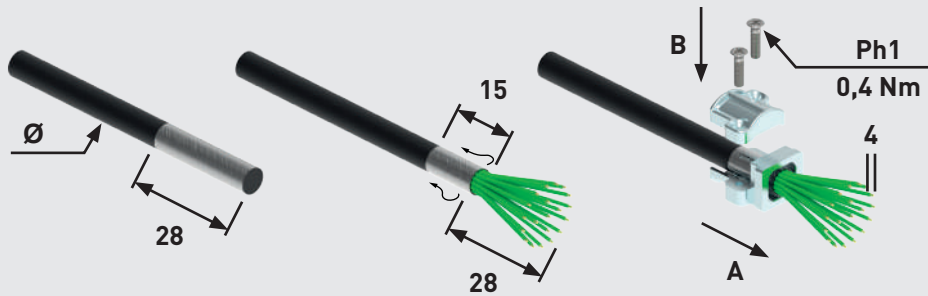

Cable clamp part No.	mm	Screw size	Tightening torque (Nm)	Recommended size of screwdriver
CX 5/7 CA	5-7	M 2,5	0,4	Ph1
CX 7/10 CA	7-10	M 2,5	0,4	Ph1
CX 10/12 CA	10-12	M 2,5	0,4	Ph1
CX 11/14 CA	11-14	M 2,5	0,4	Ph1

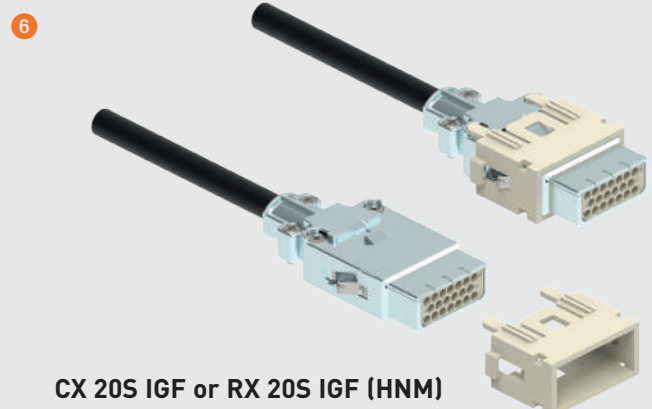
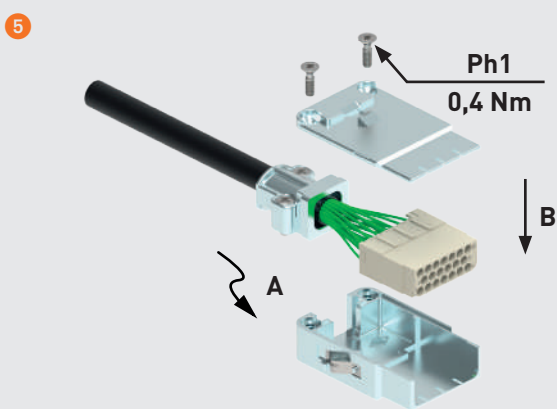
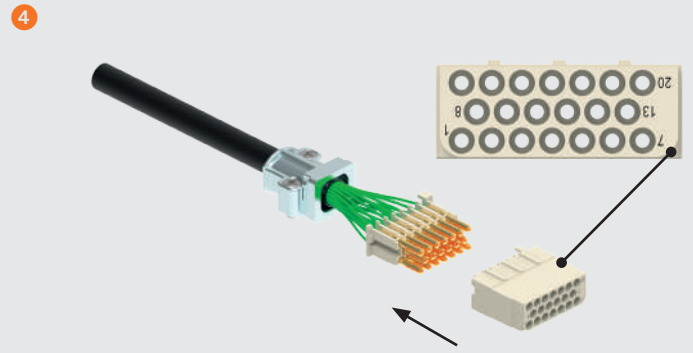
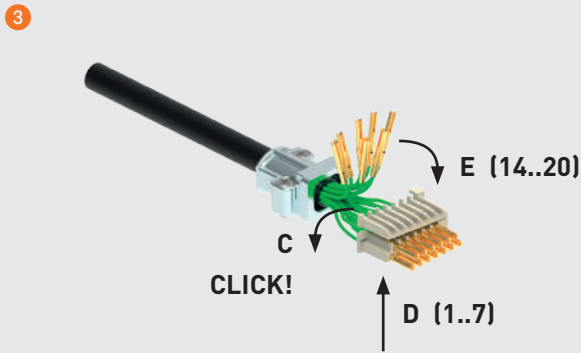
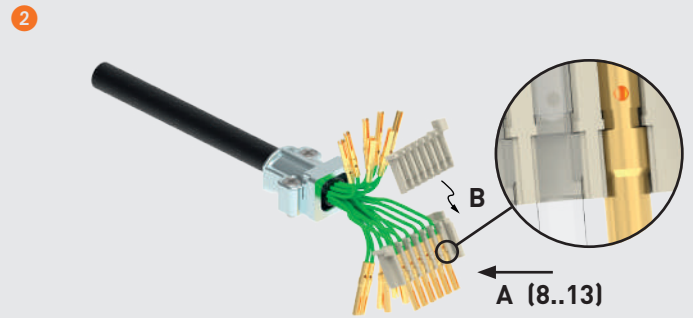
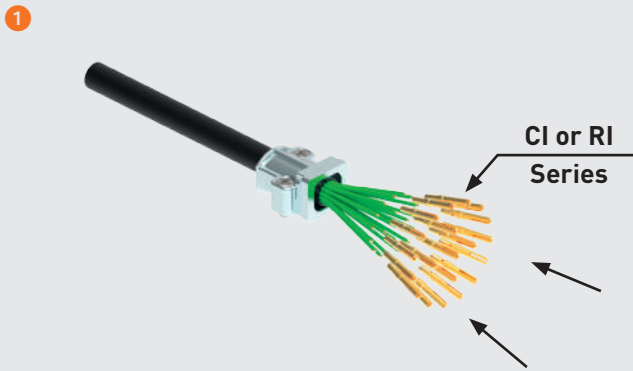

CX 20S IGF or RX 20S IGF (HNM)

# ASSEMBLY INSTRUCTIONS

## MIXO SHIELDED CX 20S IGM OR RX 20S IGM (HNM) - MALE MODULE

Watch our assembly tutorial

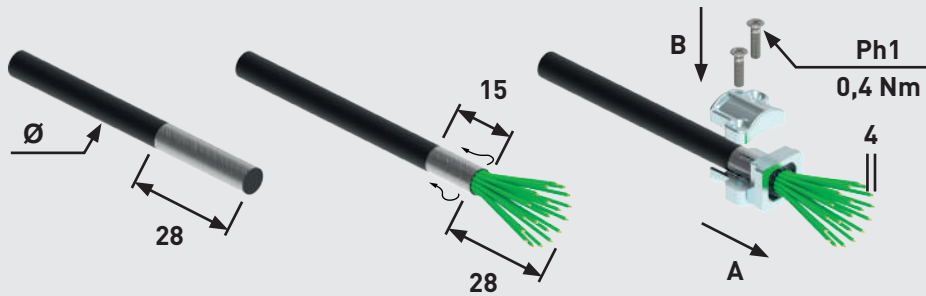

Cable clamp part No.	mm	Screw size	Tightening torque (Nm)	Recommended size of screwdriver
CX 5/7 CA	5-7	M 2,5	0,4	Ph1
CX 7/10 CA	7-10	M 2,5	0,4	Ph1
CX 10/12 CA	10-12	M 2,5	0,4	Ph1
CX 11/14 CA	11-14	M 2,5	0,4	Ph1

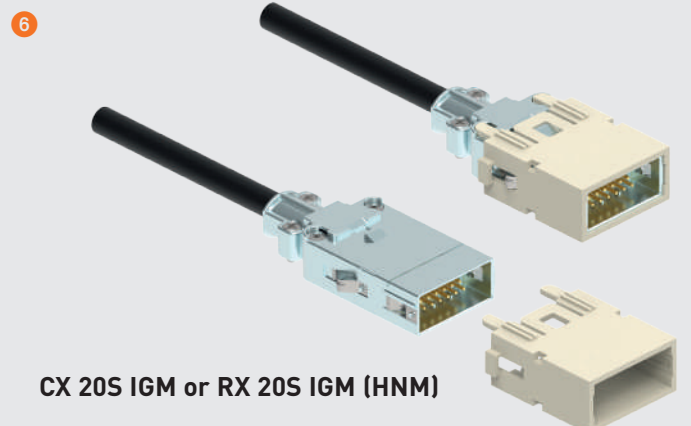
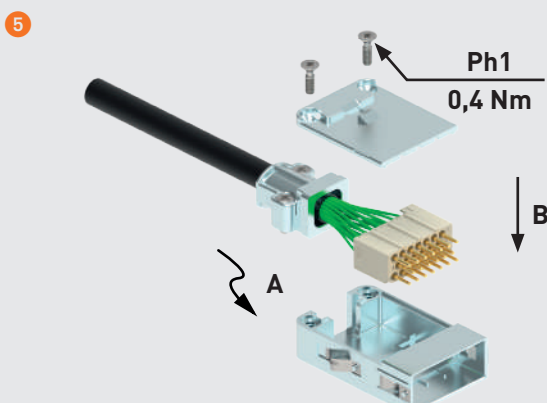
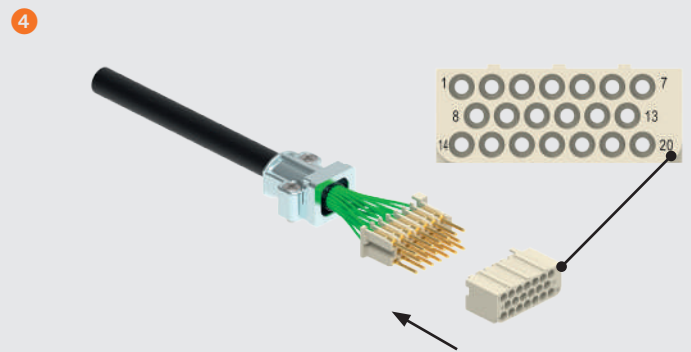
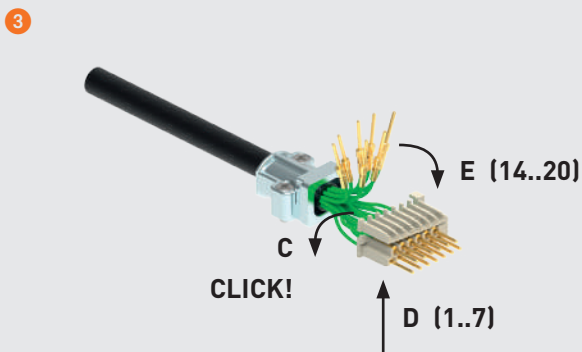
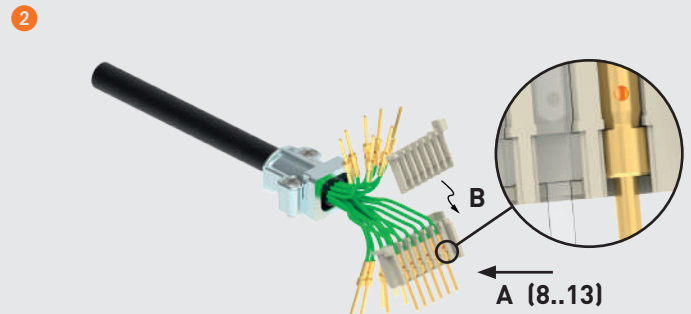
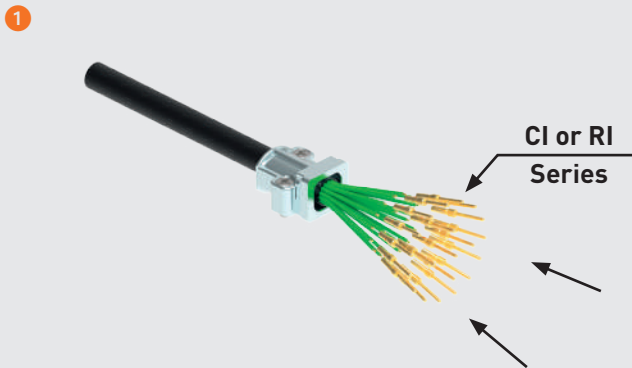

---

## MIXO PNEUMATIC METAL CX 03 MP

---

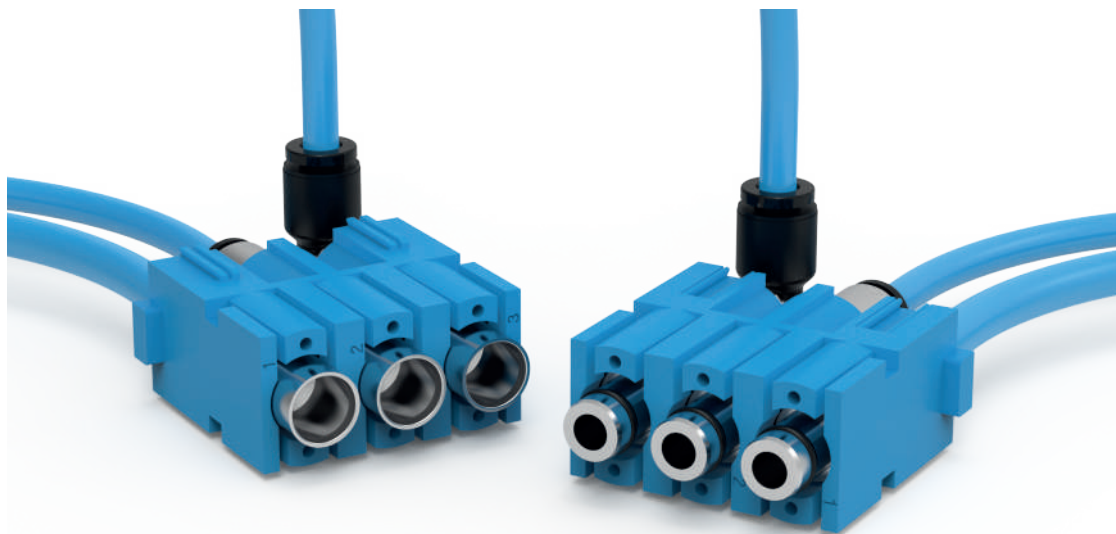

Connector module and metal removable  
pneumatic contacts

- for transmission of clean and compressed air
- straight and angled versions
- with hose barbs push-over tube attachment  
or with quick-fitting push-in tube attachment
- female contacts with/without shut-off valve
- CMPES removal tool



Find more  
information on  
our products at  
[www.ilme.com](http://www.ilme.com)

# TECHNICAL FEATURES

## CX 03 MP



Watch  
our technical  
clip

- Connector module **for up to 3 metal removable pneumatic contacts** of any of the three sizes available: 3.0, 4.0, 6.0.
- Contacts with hose barbs, push-over tube attachment, straight version only.
- Contacts with quick-fitting, push-in tube attachment, both straight and angled versions.
- All **contacts removable** without damaging the module or the contact, with **CMPEs** dedicated removal tool.
- Straight version for use with hoods with vertical cable outlet.
- Angled version for use with hoods with horizontal cable outlet.
- For tubes Ø 3 mm, Ø 4 mm and Ø 6 mm (see Table 1. below):
  - outer diameter OD (push-in attachment of tubes to the quick-fitting contacts), or
  - inner diameter ID (push-over attachment of tubes over barbed straight contacts).
- **RoHS**  
pneumatic metal module: compliant without exemptions  
metal pneumatic contacts: compliant with exemption **6(c)**.

**Table 1. Pneumatic contacts**

	Tube Ø 3 mm				Tube Ø 4 mm				Tube Ø 6 mm			
	hose barbs (ID - inner Ø)		quick-fitting (OD - outer Ø)		hose barbs (ID - inner Ø)		quick-fitting (OD - outer Ø)		hose barbs (ID - inner Ø)		quick-fitting (OD - outer Ø)	
	Male	Female	Male	Female	Male	Female	Male	Female	Male	Female	Male	Female
Straight <u>without</u> shut-off valve	CX 3.0 MPM	CX 3.0 MPF	CX 3.0 MPQM	CX 3.0 MPQF	CX 4.0 MPM	CX 4.0 MPF	CX 4.0 MPQM	CX 4.0 MPQF	CX 6.0 MPM	CX 6.0 MPF	CX 6.0 MPQM	CX 6.0 MPQF
Straight <u>with</u> shut-off valve		CX 3.0 MPV		CX 3.0 MPQV		CX 4.0 MPV		CX 4.0 MPQV		CX 6.0 MPV		CX 6.0 MPQV
Angled <u>without</u> shut-off valve			CX 3.0 MPAM	CX 3.0 MPAF			CX 4.0 MPAM	CX 4.0 MPAF			CX 6.0 MPAM	CX 6.0 MPAF
Angled <u>with</u> shut-off valve				CX 3.0 MPAV				CX 4.0 MPAV				CX 6.0 MPAV

straight version and angled version available for use with different cable outlets

with hose barbs push-over tube attachment or with quick-fitting push-in tube attachment

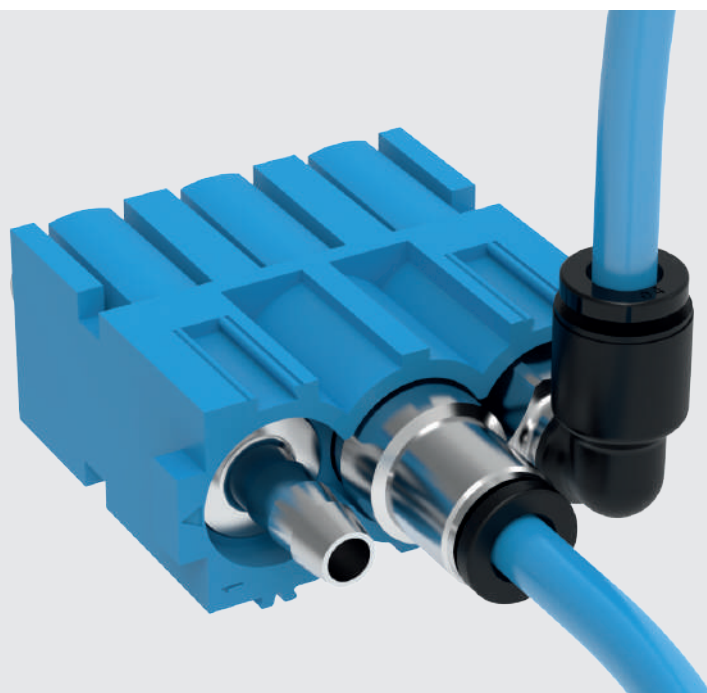

# CX 03 MP metal removable pneumatic contacts

The modular inserts must be installed in suitable frames which are then mounted in traditional housings or in COB panel support. Single-sized modular units may be directly mounted inside MIXO ONE enclosures.

modular units with 3 seats



**Q 10 000 MATINGS WITH HNM FRAMES AND HNM ENCLOSURES**

**FROM OCTOBER 2021**

metal pneumatic contacts, straight hose barbs  
tube ID inner Ø 3 - 4 - 6 mm



**FROM OCTOBER 2021**

	page:
frames for modular units	76
MIXO ONE enclosures	369

refer to CN.19 pages

description	part No.	part No.
without contacts (to be ordered separately) <b>inserts with 3 housings</b> for tube Ø 3 - 4 - 6 mm	<b>CX 03 MP</b>	
<b>hose barbs (ID inner Ø) male contacts,</b> without shut-off valve without shut-off valve without shut-off valve		<b>CX 3.0 MPM</b> <b>CX 4.0 MPM</b> <b>CX 6.0 MPM</b>
<b>hose barbs (ID inner Ø) female contacts,</b> without shut-off valve without shut-off valve without shut-off valve		<b>CX 3.0 MPF</b> <b>CX 4.0 MPF</b> <b>CX 6.0 MPF</b>
<b>hose barbs (ID inner Ø) female contacts,</b> with shut-off valve with shut-off valve with shut-off valve		<b>CX 3.0 MPV</b> <b>CX 4.0 MPV</b> <b>CX 6.0 MPV</b>

- UL, CSA, DNV-GL, BV pending
- insulation resistance:  $\geq 10 \text{ G}\Omega$
- made of self-extinguishing thermoplastic resin UL 94V-0
- **mechanical life:**  
 $\geq 10.000$  cycles  
**with HNM frame and HNM enclosures**  
 $\geq 500$  cycles  
**with MIXO frames and standard enclosures**
- working temperature range - 40 °C + + 80 °C

**Use of units for metal pneumatic contacts**

- identical male and female modular units
- pneumatic contacts for pressure values up to 10 bar, for use with clean and dry compressed air
- use of tubes with Ø 3 - 4 and 6 mm (ID inner Ø for hose barbs contacts, OD outer Ø for quick-fitting contacts), and possible replacement of tubes with assembled units
- possibility of using tubes with different diameters in the same modular unit
- female contacts with or without closing valve
- working temperature range - 40 °C + + 80 °C
- **CMPEs** removal tool \*

\* **CMPEs** removal tool



**Warnings:**

- CRM/F CX coding and guiding pins must be used for pneumatic contacts modules.
- These pins also provide coding if pneumatic contacts modules are used exclusively.
- The use of pneumatic contacts requires an appropriate filtering and dehydration system to prevent dangerous condensation.

**CX 03 MP**

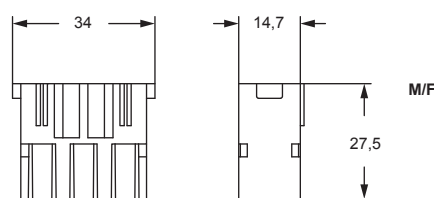

contacts side (front view)

side with reference arrow ▲

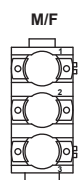

- 1 frame slot

**CX 3.0 / 4.0 / 6.0 MPM**

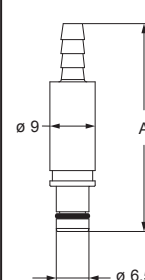

part No.	A (mm)
<b>CX 3.0 MPM</b>	37,6
<b>CX 4.0 MPM</b>	41,3
<b>CX 6.0 MPM</b>	40,2

**CX 3.0 / 4.0 / 6.0 MPF**

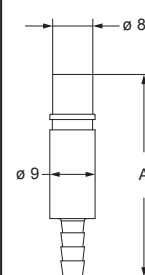

part No.	A (mm)
<b>CX 3.0 MPF</b>	36,5
<b>CX 4.0 MPF</b>	40,2
<b>CX 6.0 MPF</b>	39,1

**CX 3.0 / 4.0 / 6.0 MPV**

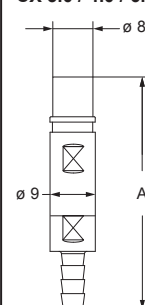

part No.	A (mm)
<b>CX 3.0 MPV</b>	42,5
<b>CX 4.0 MPV</b>	46,2
<b>CX 6.0 MPV</b>	45,1

metal pneumatic contacts, straight  
quick-fitting  
tube OD outer Ø 3 - 4 - 6 mm



FROM OCTOBER 2021

metal pneumatic contacts, angled  
quick-fitting  
tube OD outer Ø 3 - 4 - 6 mm



FROM OCTOBER 2021

description	part No.	part No.
quick-fitting (OD outer Ø) male contacts, without shut-off valve without shut-off valve without shut-off valve	straight CX 3.0 MPQM CX 4.0 MPQM CX 6.0 MPQM	angled CX 3.0 MPAM CX 4.0 MPAM CX 6.0 MPAM
quick-fitting (OD outer Ø) female contacts, without shut-off valve without shut-off valve without shut-off valve	straight CX 3.0 MPQF CX 4.0 MPQF CX 6.0 MPQF	angled CX 3.0 MPAF CX 4.0 MPAF CX 6.0 MPAF
quick-fitting (OD outer Ø) female contacts, with shut-off valve with shut-off valve with shut-off valve	straight CX 3.0 MPQV CX 4.0 MPQV CX 6.0 MPQV	angled CX 3.0 MPAV CX 4.0 MPAV CX 6.0 MPAV

CX 3.0 / 4.0 / 6.0 MPQM

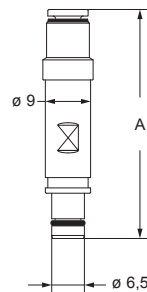

part No.	A (mm)
CX 3.0 MPQM	45,5
CX 4.0 MPQM	45,5
CX 6.0 MPQM	47,5

CX 3.0 / 4.0 / 6.0 MPAM

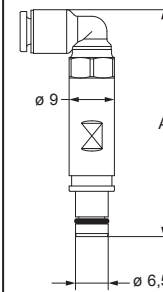

part No.	A (mm)
CX 3.0 MPAM	45,5
CX 4.0 MPAM	45,1
CX 6.0 MPAM	47,5

CX 3.0 / 4.0 / 6.0 MPQF

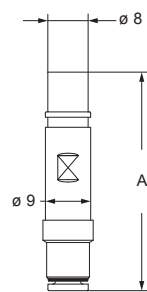

part No.	A (mm)
CX 3.0 MPQF	44,4
CX 4.0 MPQF	43,4
CX 6.0 MPQF	46,4

CX 3.0 / 4.0 / 6.0 MPAF

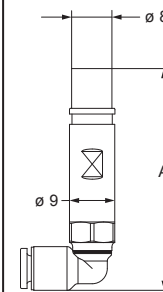

part No.	A (mm)
CX 3.0 MPAF	44,4
CX 4.0 MPAF	44,0
CX 6.0 MPAF	46,4

CX 3.0 / 4.0 / 6.0 MPQV

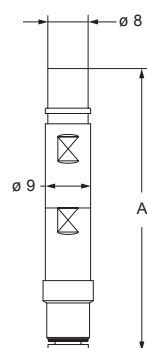

part No.	A (mm)
CX 3.0 MPQV	48,7
CX 4.0 MPQV	56,2
CX 6.0 MPQV	58,2

CX 3.0 / 4.0 / 6.0 MPAV

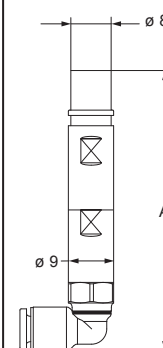

part No.	A (mm)
CX 3.0 MPAV	48,7
CX 4.0 MPAV	55,8
CX 6.0 MPAV	58,2



# CX 02 TM/TF, CX 03 TM/TF, CX 04 TM/TF, CX 06 TM/TF

enclosures:	page:
C-TYPE IP65 or IP66/IP69	387 - 430
C7 IP67	436 - 442
V-TYPE IP65 or IP66/IP69	444 - 463
BIG hoods	466 - 473
T-TYPE IP65 insulating	480 - 487
T-TYPE / W IP66/IP69 insulating	489 - 492
HYGIENIC T-TYPE / H IP66/IP69	501 - 504
HYGIENIC T-TYPE / C IP66/IP69, -50 °C	506 - 509
W-TYPE for aggressive environments	521 - 526
E-Xtreme® corrosion proof	530 - 537
	542 - 547
	550 - 557
EMC	578 - 581
Central lever	603 - 614
LS-TYPE	618 - 625
IP68	632 - 647
panel supports:	
COB	652 - 653

refer to CN.19 pages

## frames for modular units with lock-in tab (included)

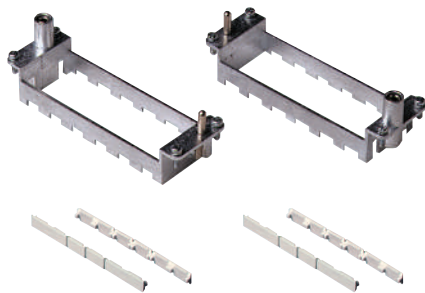

description	part No.	part No.
frames for modular units, with lock-in tab included	type for hoods*	type for housings*
for 2 modular units - for housing size 44.27	<b>CX 02 TM</b>	<b>CX 02 TF</b>
for 3 modular units - for housing size 57.27	<b>CX 03 TM</b>	<b>CX 03 TF</b>
for 4 modular units - for housing size 77.27 and 77.62	<b>CX 04 TM</b>	<b>CX 04 TF</b>
for 6 modular units - for housing size 104.27 and 104.62	<b>CX 06 TM</b>	<b>CX 06 TF</b>

- die-cast zinc alloy frames
- protective earth (PE)
- possibility of mounting female and male modular units on the same frame
- frames supplied with lock-in tab to attach units
- polarisation on frames
- coding pins **CR..CX**
- for spare lock-in tab **CX CFM** see SPARE SPARTS catalogue

\* Assignment of attribute "for hoods" or "for housings" is merely conventional: both types can be mounted either in a hood or in a housing. In a modular connector coupling there shall be always a frame type "M" and a frame type "F".

### CX TM / TF

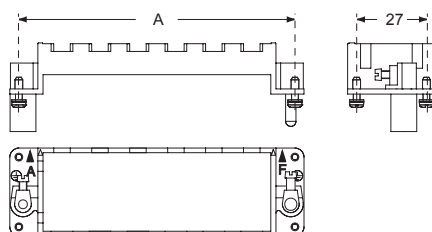

part No.	A (mm)	for housings size
<b>CX 02 TM / TF</b>	44	44.27
<b>CX 03 TM / TF</b>	57	57.27
<b>CX 04 TM / TF</b>	77,5	77.27 and 77.62
<b>CX 06 TM / TF</b>	104	104.27 and 104.62

### Earth terminal

- large: for cables from 4-6 mm<sup>2</sup>, AWG 12-10
- small: for cables from 1-2,5 mm<sup>2</sup>, AWG 18-14

In order to accommodate larger PE conductor cross-sectional area, use CGT PE adapters, see page 319.

position of modules (contact side view)

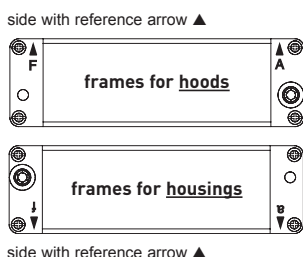

### CX CFM (lock-in tab)

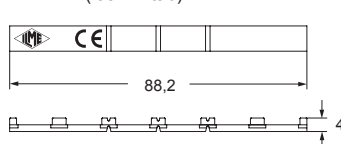

## Polarisation of frames with relative identification letters and couplings

frame for hoods<sup>1)</sup> frames for housings<sup>1)</sup>

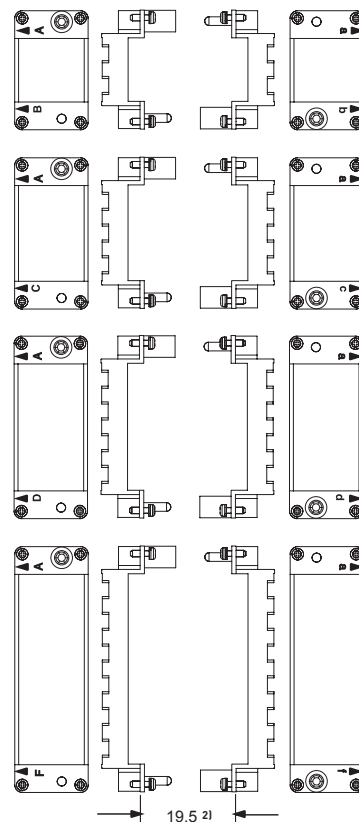

### 1) Warning:

- The module support frames are marked:
- FOR HOODS: **upper-case A-B, A-C, A-D and A-F**
- FOR HOUSINGS: **lower-case a-b, a-c, a-d and a-f**

Positioning the modules in the frames according to the respective letters is ensuring the specular assembly of modules, for which the hood will be coupled correctly to the housing.

### 2) Distance for:

- electric and fibre optic contacts: max 21 mm
- pneumatic contacts: max 20,5 mm



# RX 02 TM/TF, RX 03 TM/TF, RX 04 TM/TF, RX 06 TM/TF HNM (High Number of Matings)

enclosures size:

pages:

"44.27"	HNM	592 - 593
	C-TYPE IP65/IP66, single lever	387 - 392
	V-TYPE IP65/IP66, single lever	444 - 447
	E-Xtreme® corrosion proof	530-531, 542, 550-551
"57.27"	HNM	594 - 595
	C-TYPE IP65/IP66, single lever	393 - 401
	V-TYPE IP65/IP66, single lever	448 - 453
	E-Xtreme® corrosion proof	532-533, 543, 552-553
"77.27"	HNM	596 - 597
	C-TYPE IP65/IP66, single lever	402 - 411
	V-TYPE IP65/IP66, single lever	454 - 458
	E-Xtreme® corrosion proof	534-535, 544, 554-555
"104.27"	HNM	598 - 599
	C-TYPE IP65/IP66, single lever	412 - 423
	V-TYPE IP65/IP66, single lever	459 - 463
	E-Xtreme® corrosion proof	536-537, 545, 556-557
"77.62"	C-TYPE IP65/IP66, single lever	424 - 429
	E-Xtreme® corrosion proof	546
	"104.62"	C-TYPE IP65/IP66, single lever
	E-Xtreme® corrosion proof	547

refer to CN.19 pages

## frames for modular units with lock-in tab (included)

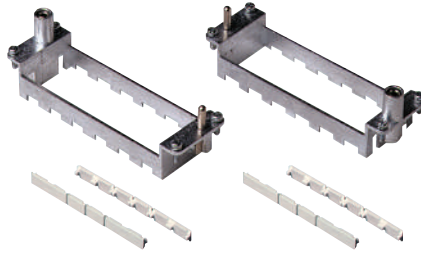

## Q 10 000 MATINGS WITH HNM FRAMES AND HNM ENCLOSURES

description	part No.	part No.
frames for modular units, with lock-in tab included	type for hoods*	type for housings*
for 2 modular units - for housing size 44.27	<b>RX 02 TM</b>	<b>RX 02 TF</b>
for 3 modular units - for housing size 57.27	<b>RX 03 TM</b>	<b>RX 03 TF</b>
for 4 modular units - for housing size 77.27 and 77.62	<b>RX 04 TM</b>	<b>RX 04 TF</b>
for 6 modular units - for housing size 104.27 and 104.62	<b>RX 06 TM</b>	<b>RX 06 TF</b>

C-TYPE and V-TYPE 2-lever versions cannot be used to reach 5.000 matings.

- die-cast zinc alloy frames
- protective earth (PE)
- possibility of mounting female and male modular units on the same frame
- frames supplied with lock-in tab to attach units
- polarisation on frames
- coding pins **CR..CX**
- for spare lock-in tab **CX CFM** see SPARE SPARTS catalogue

\* Assignment of attribute "for hoods" or "for housings" is merely conventional: both types can be mounted either in a hood or in a housing. In a modular connector coupling there shall be always a frame type "M" and a frame type "F".

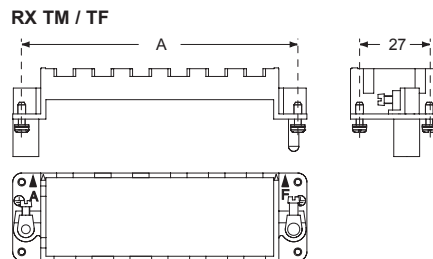

part No.	A (mm)	for housings size
<b>RX 02 TM / TF</b>	44	44.27
<b>RX 03 TM / TF</b>	57	57.27
<b>RX 04 TM / TF</b>	77,5	77.27 and 77.62
<b>RX 06 TM / TF</b>	104	104.27 and 104.62

### Earth terminal

- large: for cables from 4-6 mm<sup>2</sup>, AWG 12-10
- small: for cables from 1-2,5 mm<sup>2</sup>, AWG 18-14

In order to accommodate larger PE conductor cross-sectional area, use CGT PE adapters, see page 319 CN.19 catalogue.

position of modules (contact side view)

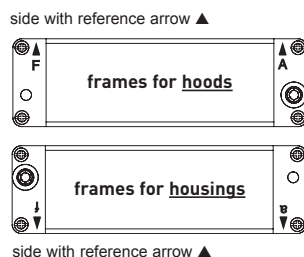

### CX CFM (lock-in tab)

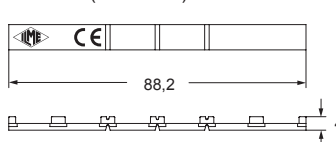

## Polarisation of frames with relative identification letters and couplings

frame for hoods <sup>1)</sup> frames for housings <sup>1)</sup>

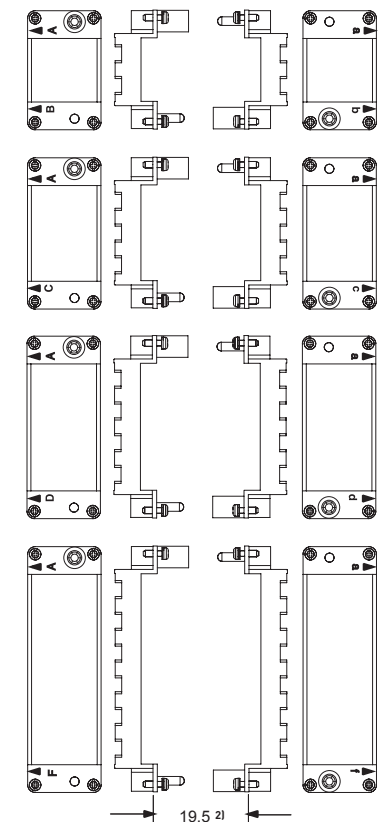

### 1) Warning:

- The module support frames are marked:
- FOR HOODS: **upper-case A-B, A-C, A-D and A-F**
- FOR HOUSINGS: **lower-case a-b, a-c, a-d and a-f**

Positioning the modules in the frames according to the respective letters is ensuring the specular assembly of modules, for which the hood will be coupled correctly to the housing.

### 2) Distance for:

- electric and fibre optic contacts: max 21 mm
- pneumatic contacts: max 20,5 mm

---

## CX7 SERIES FINGERPROOF MALE CRIMP CONTACTS

### CX7MA 6.0 / 10 / 16 / 25 P

---

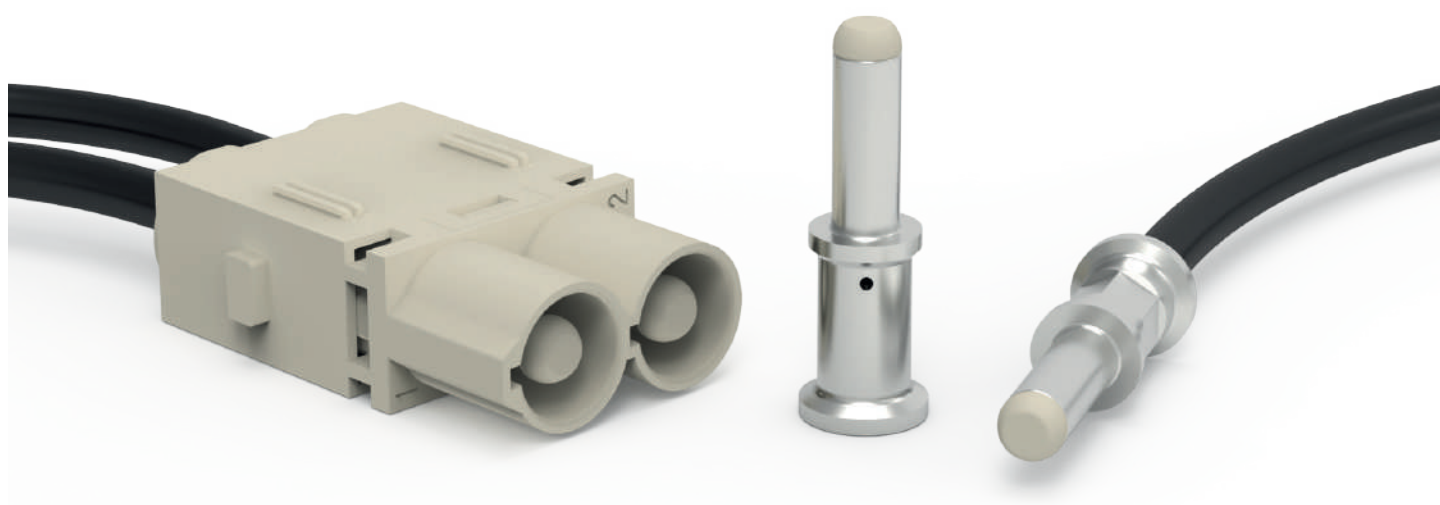

CX7 series male crimp contacts,  
variants with insulating cap



Find more  
information on  
our products at  
[www.ilme.com](http://www.ilme.com)

## TECHNICAL FEATURES

### CX7MA 6.0 / 10 / 16 / 25 P



Watch  
our technical  
clip

For the benefit of male MIXO module **CX 02 7M**, the **CX7** series is now expanded by adding a variant of **male contacts with insulating cap** on their tip, likely to determine in combination with this male module the **fingerproof safety** feature.

This feature is particularly advantageous in all applications where male connector inserts feed electric motors equipped with power drives, such drives being often equipped motor side with **capacitors** that may remain charged with hazardous voltage present on the pin contacts of the connector for a few times after switching off the motor and unplugging the connector.

NOTE – The new crimp combined connector inserts **CXM 4/2** and **CXM 4/8** for use with **CX7MA** power male crimp contacts and **CCMA** auxiliary male crimp contacts, cannot take advantage of **CX7MA ... P fingerproof** contacts, in that these inserts, for legacy with the traditional screw-type models, could not be provided with shrouded seats for male contacts as in **MIXO CX 02 7M**.

Tip made by polycarbonate (same as those of the inserts), light grey colour.

All other features are in common with **CX7** contacts (i.e. crimping tools, dimensions, materials, etc.).

**RoHS**: compliant with exemption **6(c)**.

tip made by  
polycarbonate  
light grey colour  
for fingerproof  
safety

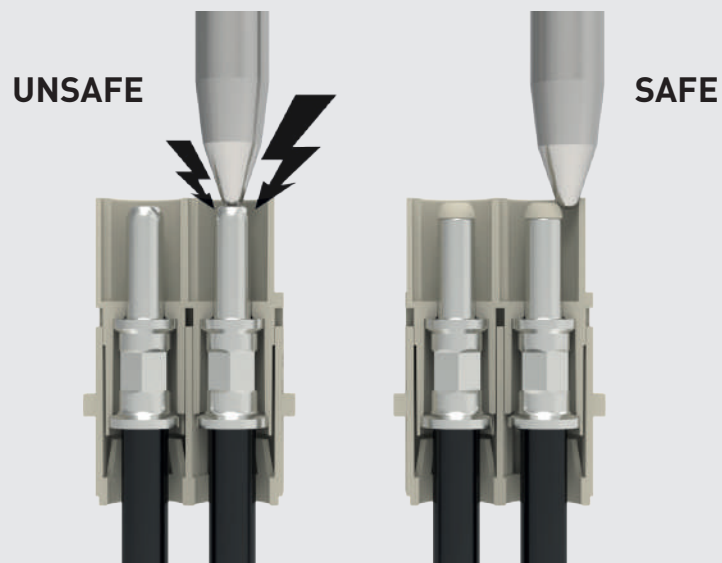

inserts

page:

70 A silver plated fingerproof  
male crimp contacts

MIXO (CX 02 7M)

70 A

266



refer to CN.19 pages

description

part No.

70 A male crimp contacts fingerproof

6 mm<sup>2</sup> AWG 1010 mm<sup>2</sup> AWG 716 mm<sup>2</sup> AWG 525 mm<sup>2</sup> AWG 3

CX7MA 6.0 P

CX7MA 10 P

CX7MA 16 P

CX7MA 25 P

silver  
plated

- it is recommended to crimp the contacts with crimping tools homologated by ILME (please see the crimping tool section 70A contacts, CX7MA...P series) on pages 720 - 721 of CN.19 catalogue

- C7ES removal tool (see page 720 of CN.19 catalogue)

CX7MA .. P

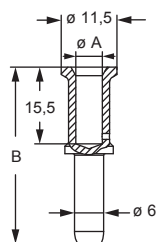

CX7MA .. P contacts

part No.	ø A (mm)	B (mm)	stripping length (mm)
CX7MA 6.0 P	3,5	36,6	15
CX7MA 10 P	4,3	35,8	15
CX7MA 16 P	5,5	35,8	15
CX7MA 25 P	7,0	35,8	15

**CX7MA 6.0 / 10 / 16 / 25 P - 70 A FINGERPROOF MALE CRIMP CONTACTS**



---

## PCB INTERFACE ADAPTER

### CIF X17 2.4

---

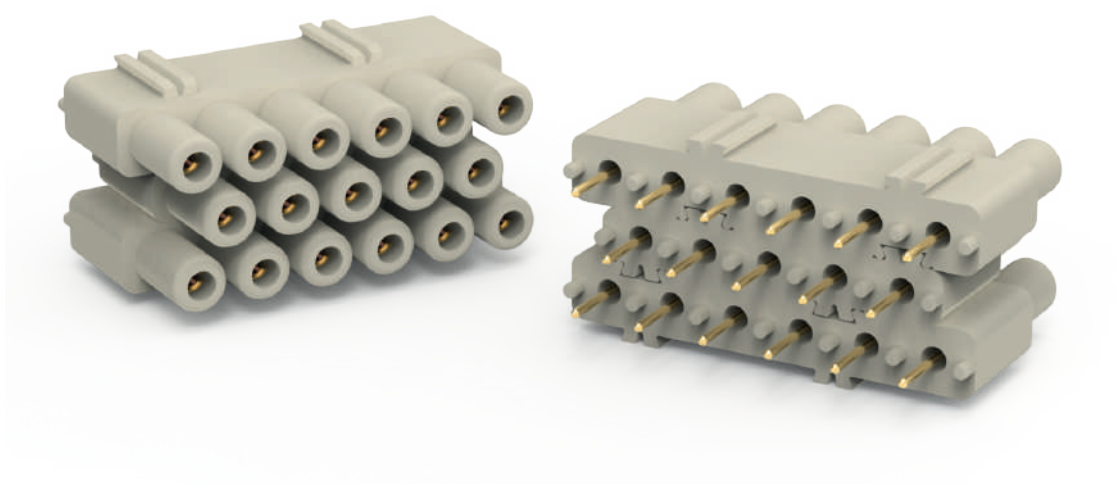

New CIF X17 2.4  
(CIF 5 2.4 5P interface adapter  
+ 2× CIF 2.4, 6P interface adapter)  
for MIXO CX 17 DF/M module



Find more  
information on  
our products at  
[www.ilme.com](http://www.ilme.com)

## TECHNICAL FEATURES

### CIF X17 2.4

#### **CIF X17 2.4** **(complete set of 2× CIF 2.4 + new CIF 5 2.4)**

Interface PCB adapter for up to 2,4 mm thick PCBs, gold plated contacts suitable for high-density MIXO module **CX 17 DF/ DM**.

#### **CIF 5 2.4** **(5P interface adapter alone)**

For customers already using **CIF 2.4\*** available also as **CIF 5 2.4**, stand-alone additional 5P interface adapter, to be completed by 2× CIF 2.4.

\* See CN.19 p. 670, 6-pole PCB adapter, suitable in multiple units to provide PCB interface for series **CDD** inserts size **24** (4 units) **42** (7 units), **72** (12 units) and **108** (13 units), the 24-pole section of combined connector inserts **CX 8/24** (3 units) or the 36-pole section of **CX 6/36** (6 units), and MIXO **CX 12 DF/ DM** modules (2 units), see CN.19 p. 282.

The new 5-pole interface adapter connector **CIF 5 2.4** of series **CIF**, once mounted in-between **2× CIF 2.4**, 6-pole interface adapter connectors, forms a 17-pole PCB interface “block” equipped with female gold-plated contacts with rear post for soldering to the PCB.

Either so grouped, or conveniently purchased in the dedicated complete set **CIF X17 2.4**, it serves as interface for either a male or a female high-density module **CX 17 DF** or **CX 17 DM** of series MIXO, each equipped with corresponding interface contacts **CDFA 6A** or **CDMA 6A32** (silver plated) with rear post Ø 1 mm suitable for mating with the CIF adapter female contacts.

**RoHS:** compliant with exemption **6(c)**.

example of use  
of CIF X17 2.4  
on a PCB

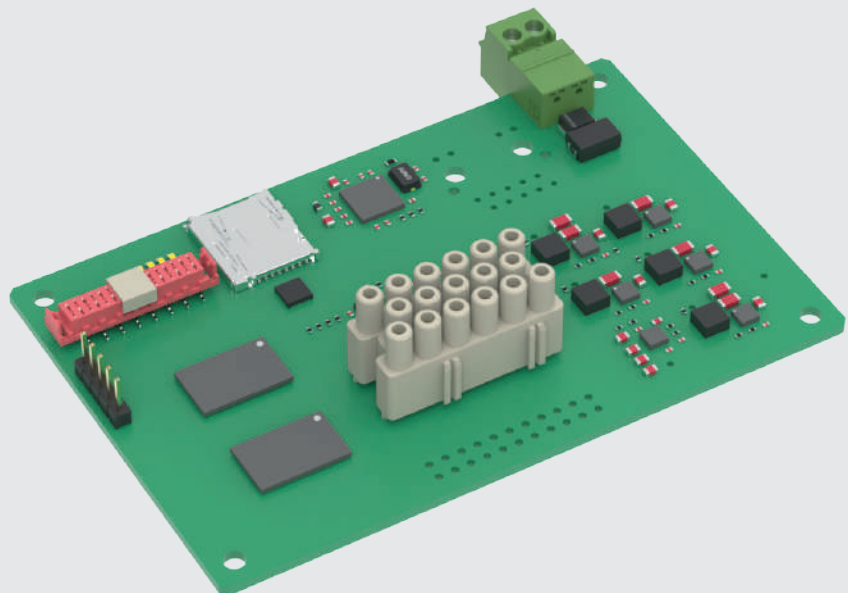

# CIF X17 2.4 PCB interface adapter for CX 17 DF /DM modular inserts

inserts

page:

PCB interface adapter for CX 17 DF /DM modular inserts

6 A interface contacts, silver plated, terminal Ø 1 mm

MIXO (CX DF /DM) 17 poles

282

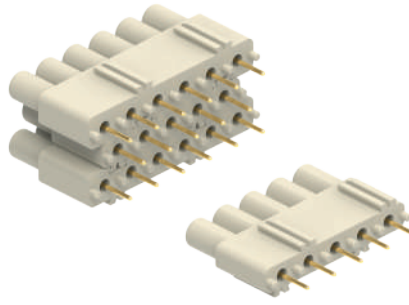

refer to CN.19 pages

**FROM JULY 2021**

description	part No.	part No.
PCB interface adapter, <u>complete set</u> , with 17 contacts for up to 2,4 mm thick PCBs	<b>CIF X17 2.4</b>	
PCB interface adapter, <u>5P alone</u> , to be combined with 2x CIF 2.4	<b>CIF 5 2.4</b>	
6A interface contacts for female inserts with terminal Ø 1 mm		<b>CDFA 6A</b>
6A interface contacts for male inserts with terminal Ø 1 mm		<b>CDMA 6A32</b>

silver plated

- characteristics according to EN/IEC 61984 ratings: **7,5 A 160 V 2,5 kV 3**
- cUL (UL for USA and Canada), CSA, CQC, DNV-GL, BV pending
- rated voltage according to UL/CSA: 160 V
- insulation resistance:  $\geq 10 \text{ G}\Omega$
- ambient temperature limit:  $-40 \text{ }^\circ\text{C} \dots +125 \text{ }^\circ\text{C}$
- material (insert): polycarbonate
- material (contacts): copper alloy
- RoHS: compliant with exemption
- RoHS exemptions: 6c - Copper alloy containing up to 4% lead by weight

The adapter is soldered on the printed circuit on which the multipole connector (female or male) equipped with interface contacts will then be inserted.

**CIF X17 2.4**

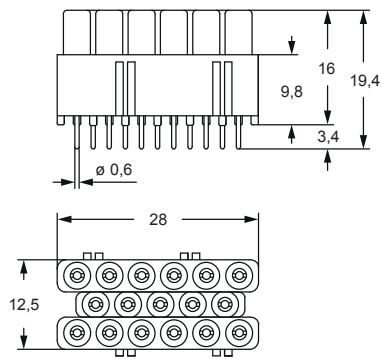

**PCB LAYOUT**

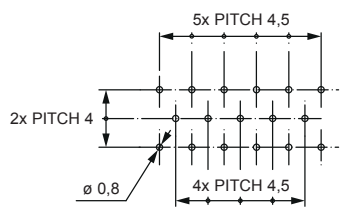

**CIF 5 2.4**

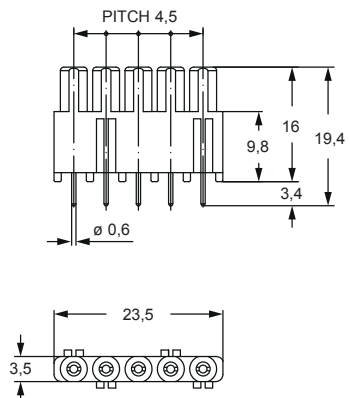

**CDFA 6A and CDMA 6A32**

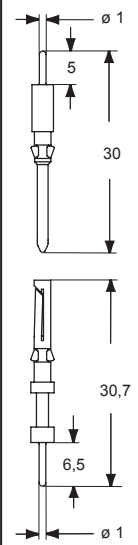

**CIF X17 2.4 COMPLETE SET**

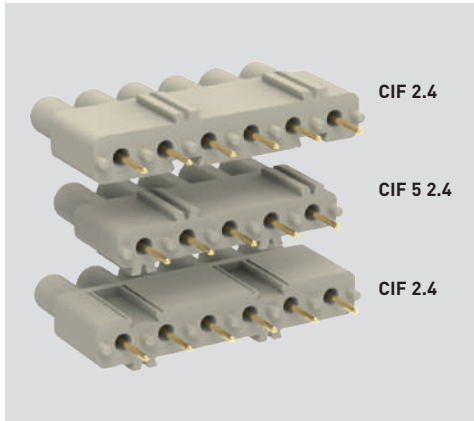



# ASSEMBLY INSTRUCTIONS

## CIF X17 2.4 CONNECTION

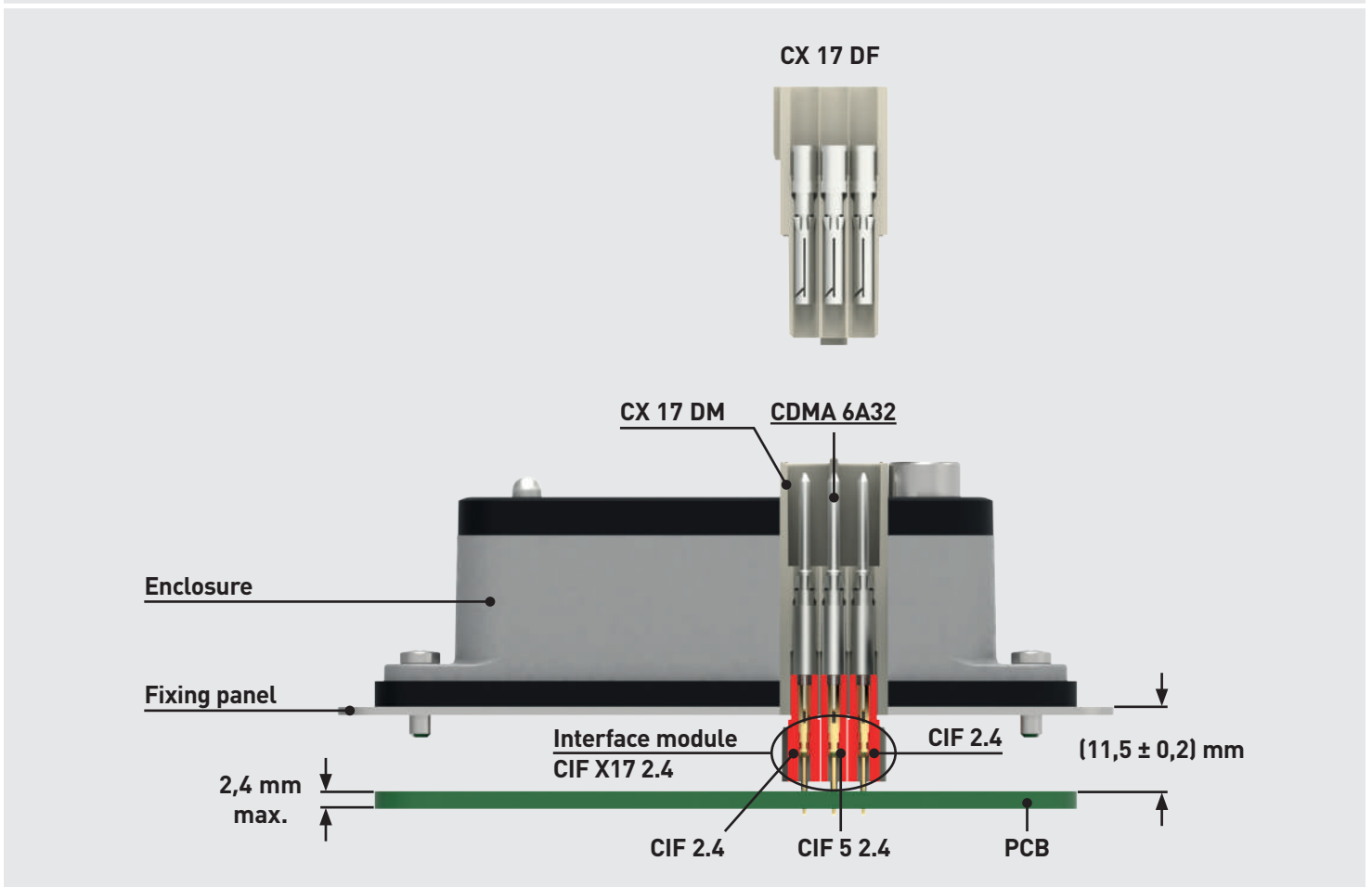
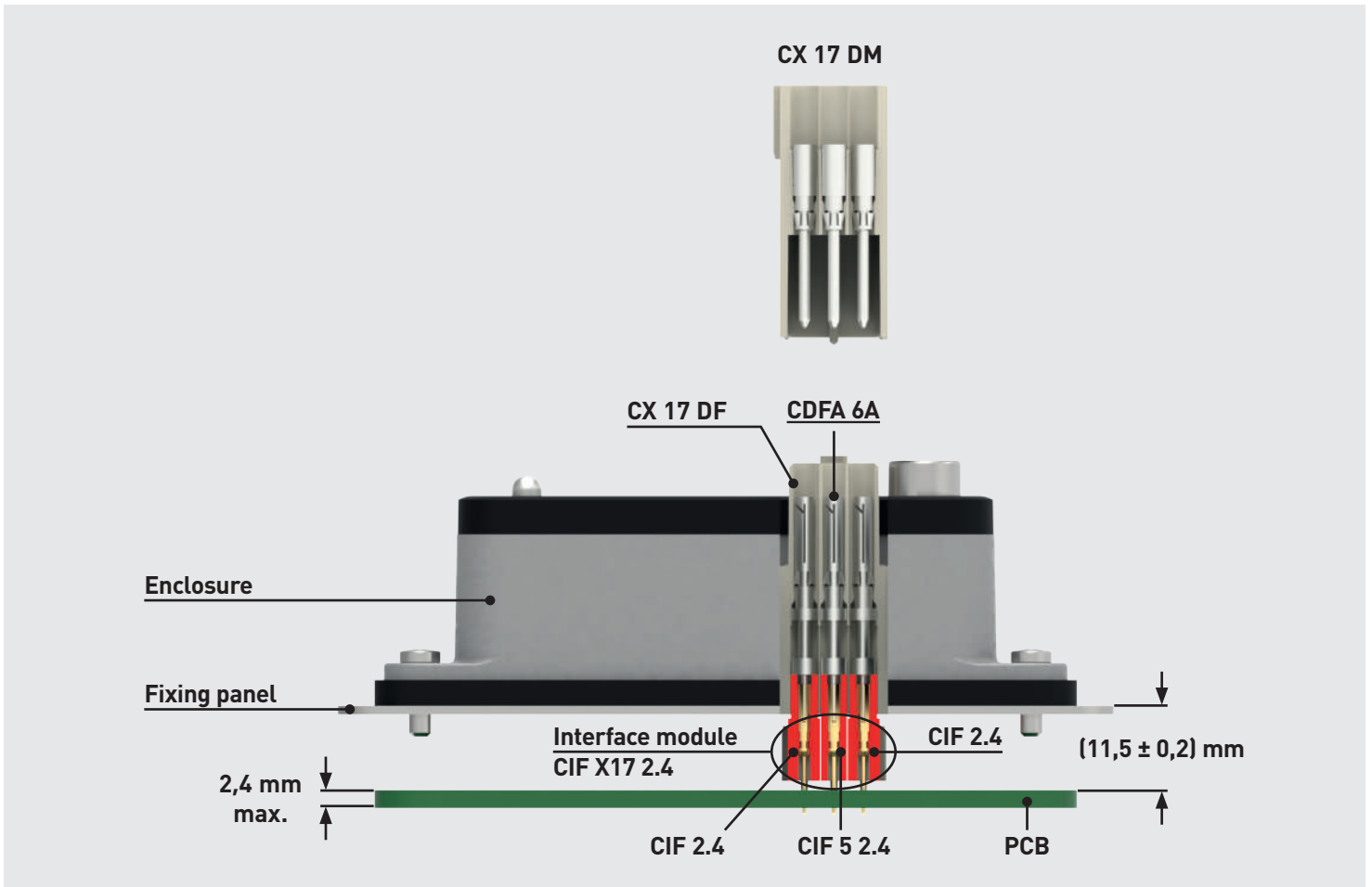

---

**RJ45 COUPLER  
IN ANGLED BULKHEAD MOUNTING HOUSINGS  
CJZA 8 IA4, CJZAX 8 IA4, CJZAXX 8 IA4**

---



90° angled RJ45  
female-female coupler  
in bulkhead-mount angled “21.21”  
metal housing with 4 fixing screws



Find more  
information on  
our products at  
[www.ilme.com](http://www.ilme.com)

## TECHNICAL FEATURES

### CJZA 8 IA4, CJZAX 8 IA4, CJZAXX 8 IA4

This new **90° angled** female-female RJ45 coupler, housed in a sturdy bulkhead-mounting **angled “21.21” metal housing with 4 fixing screw on the flange**, once installed on the vertical wall of a control panel enclosure, enables the corresponding male RJ45 connector being oriented **vertically**, along the wall of the control panel, so as to **avoid undue torque (leverage effect)** on the connector locking lever, due to the weight of the attached cable and the lever arm that a horizontally placed hood and gland would imply.

This RJ45 female/female adapter is fitted with two PCB-mounted **RJ45 Cat. 5** female connectors (jacks) on a specially designed PCB, and allows use of patch cords both on the inside and the outside of a control panel, e.g. using the universal patch cord adapter CJK 8M in corresponding hood on the outside of the panel.

IP66/IP67/IP69 degree of protection when mated and locked.

NOTE - The sealing on the 4 pass-through fixing screw must be verified by the customer.

**RoHS:** compliant without exemptions.

avoids  
undue leverage  
on the connector  
locking lever

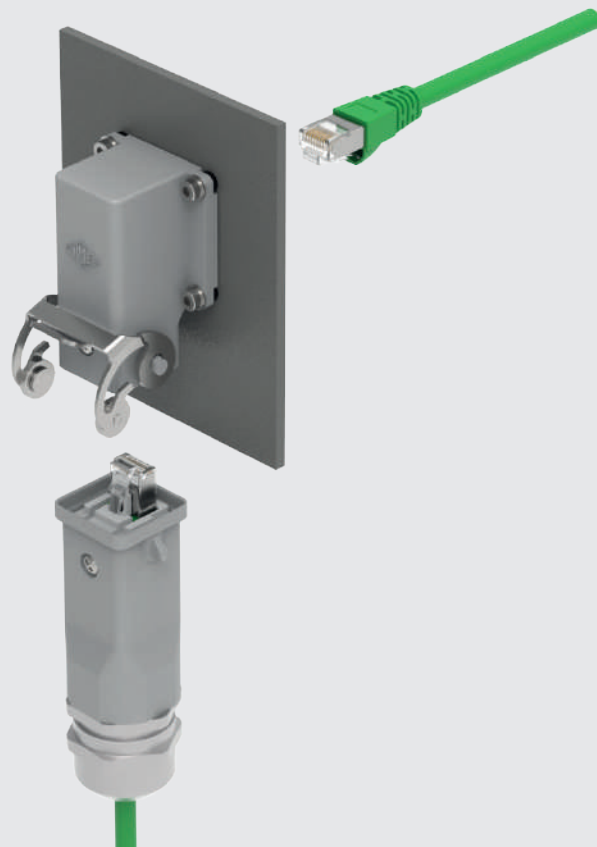

# CJZAX - CJZA RJ45 coupler

angled bulkhead mounting housings with RJ45 coupler



**STAINLESS STEEL LEVER**  
**FROM SEPTEMBER 2021**

angled bulkhead mounting housings with RJ45 coupler



**GALVANIZED STEEL RIGID LEVER**  
**FROM SEPTEMBER 2021**

description	part No.	part No.
-------------	----------	----------

angled bulkhead mounting housings with RJ45 coupler with stainless steel lever

**CJZAX 8 IA4**

angled bulkhead mounting housings with RJ45 coupler with galvanized steel rigid lever

**CJZA 8 IA4**

- IP66/IP67/IP69 degree of protection (EN 60529)
- RJ45 coupler, CAT. 5 Ethernet
- rated current: 2.1A at 70 °C
- rated voltage: 50V DC / 35V AC
- temperature limit: -40 °C, +120 °C
- nickel-plated brass shielding
- insert coding pin: **CR KC \***
- self-extinguishing: UL 94V-0
- enclosures in zinc alloy

**\* CR KC insert coding pin**

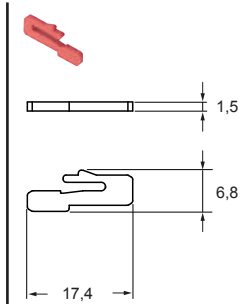

How to use CR KC coding pins (see page 224 of CN.19 Catalogue)

**CJZAX 8 IA4**

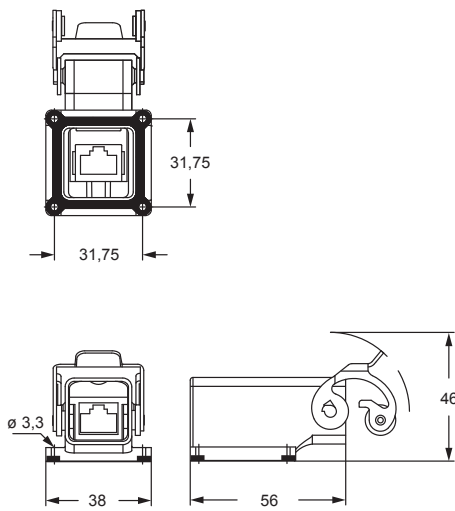

panel cut-out for CJZAX 8 IA4

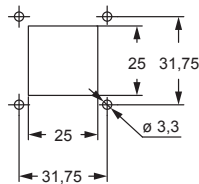

**CJZA 8 IA4**

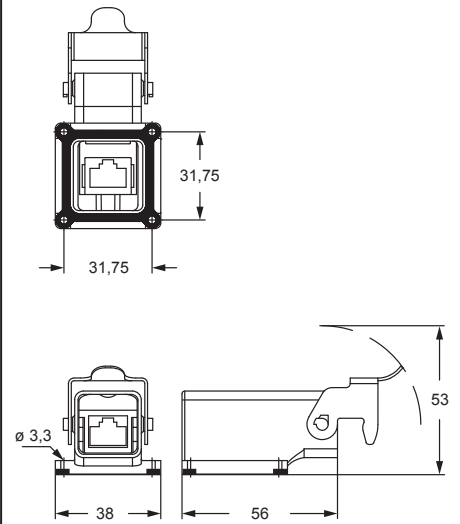

panel cut-out for CJZA 8 IA4

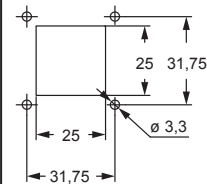

# CJZAXX RJ45 coupler

angled bulkhead mounting housings with RJ45 coupler



**STAINLESS STEEL RIGID LEVER**  
**FROM SEPTEMBER 2021**

description	part No.
-------------	----------

angled bulkhead mounting housings with RJ45 coupler with stainless steel rigid lever

**CJZAXX 8 IA4**

- IP66/IP67/IP69 degree of protection (EN 60529)
- RJ45 coupler, CAT. 5 Ethernet
- rated current: 2.1A at 70 °C
- rated voltage: 50V DC / 35V AC
- temperature limit: -40 °C, +120 °C
- nickel-plated brass shielding
- insert coding pin: **CR KC \***
- self-extinguishing: UL 94V-0
- enclosures in zinc alloy

**CJZAXX 8 IA4**

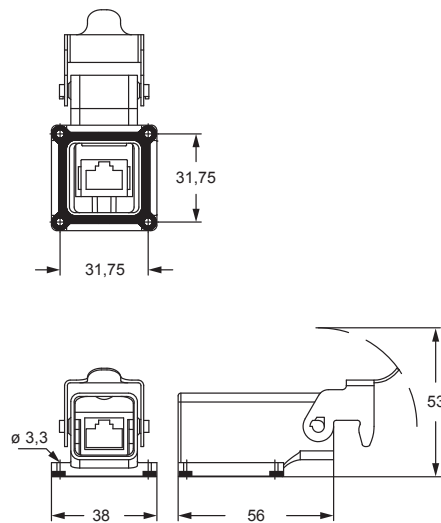

\* **CR KC**  
insert coding pin

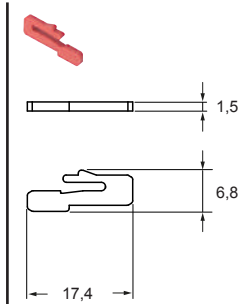

How to use CR KC coding pins  
(see page 224 of CN.19 Catalogue)

panel cut-out for CJZAXX 8 IA4

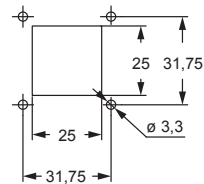

---

**M32 BULKHEAD MOUNT HOUSING  
WITH FLANGE GASKET  
MKA IFC, MKAX IFC, MKAXX IFC**

---



"21.21" bulkhead mount  
 housings variant with flange  
 sealing gasket with elevated edge  
 instead of O-ring of MKA ... IF



Find more  
 information on  
 our products at  
 [www.ilme.com](http://www.ilme.com)

## TECHNICAL FEATURES

### MKA IFC, MKAX IFC, MKAXX IFC

Variant with flange sealing gasket with elevated edge instead of O-ring, of **MKA ... IF** bulkhead mounting connector housings, available with:

- standard galvanized steel rigid lever (no additional letter in the pre-code);
- "Class" stainless steel with rolls (additional letter **X** in the pre-code);
- rigid stainless steel lever (additional letters **XX** in the pre-code)

for all inserts size "21.21" suitable for metallic enclosures\* with round M32 male threaded appendix underneath the flange, to be fixed on an M32 threaded hole on a panel, where the O-ring gasket is replaced by a flange gasket with elevated edge (ILME proprietary design).

\* CDF /M 07, having pass-through PE contact, is not suitable for installation in metallic enclosures.

Whereas the O-ring gasket versions are mostly targeting applications where the threaded male appendix is used for screwing onto a female threaded hole, the new variants with flange plane gasket (suffix **C** as for "counternut") are best fitting applications on pass-through hole and M32 counternut, filling better the space below the flange.

**Standard** types available.

For **W-Type** (aggressive environment), **EMC** (improved shielding effectiveness) and **180 °C** (high temperatures) versions please contact ILME Commercial Offices.

IP44, IP66/IP67/IP69 with CKR 65(D)

 Type 12, Type 4, 4X  
when used with CKR 65 (D)

**RoHS:** compliant with exemption **6(c)**.

flange sealing gasket  
with proprietary design  
elevated edge

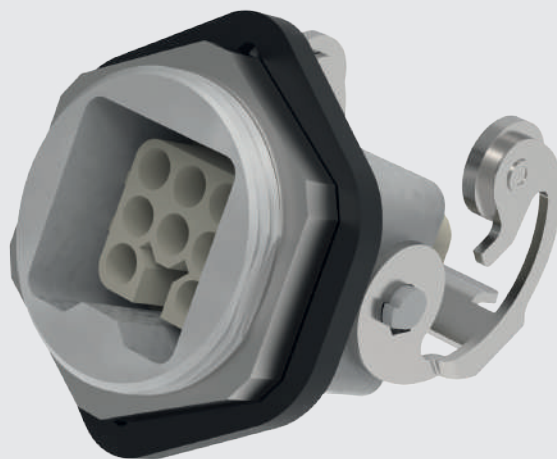

# MKAX IFC standard metallic version with flange gasket

**inserts**

<b>CK</b>	3 and 4 poles + ⊕	<b>58</b>
<b>CKS</b>	3 and 4 poles + ⊕	-
<b>CKSH</b>	3 and 4 poles + ⊕	<b>63</b>
<b>CD</b>	8 poles	<b>67</b>
<b>CQ4</b>	2 poles + ⊕	<b>182</b>
<b>CQ4 H</b>	2 poles + ⊕	<b>183</b>
<b>CQ4</b>	3 poles + ⊕	<b>184</b>
<b>CQ</b>	5 poles + ⊕	<b>186</b>
<b>CQ</b>	7 poles + ⊕	<b>187</b>
<b>CQ</b>	12 poles + ⊕	<b>189</b>
<b>CQ</b>	21 poles	<b>190</b>
<b>CJ KF</b>		<b>223</b>
<b>CJK 8FT</b>		<b>226</b>
<b>CJK 8IFT</b>		<b>228</b>
<b>CLK 04 SC</b>		<b>239</b>
<b>CX 1/2 BD</b>		<b>243</b>
<b>CXL 2/4 SF/SM</b>		<b>250</b>
<b>CXL SF/SM</b>		<b>250</b>
<b>CXL 2/4 PF/PM</b>		<b>251</b>
<b>CXL 2/4 PFH/PMH</b>		<b>251</b>
<b>CXL PF/PM</b>		<b>251</b>

page:

**bulkhead mounting housings with flange gasket**



**STAINLESS STEEL LEVER**

refer to CN.19 pages

description	part No. (entry M32)
M32 fixing thread <sup>1)</sup>	<b>MKAX IFC</b>
gasket and screw kit for IP66/IP67/IP69 <sup>1)</sup>	<b>CKR 65</b>
gasket and screw kit for IP66/IP67/IP69 <sup>1)</sup> specific for CD 08 inserts	<b>CKR 65 D</b>

<sup>1)</sup> To obtain the IP66/IP67/IP69 degree of protection it is necessary to replace the fixing screw supplied with all inserts, with the one with gasket included in the kit (to be purchased separately) **except for** the inserts listed below (already supplied with a fixing screw with gasket):

- CQF/M 07, CQF/M 12
- CJ KF
- CJK 8FT /8IFT
- CX 1/2 BDF/M
- CLK 04 SCF /SCF-H /SCM
- CXL 2/4 PF /PM /PFH /PMH /SF /SM, CXL SF/M
- CXL PF /PM

**NOTE:** The enclosure shown here is an example. The screw and sealing gasket kit can be used with all enclosures' part nos. in this page

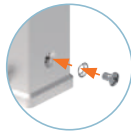

**MKAX IFC**

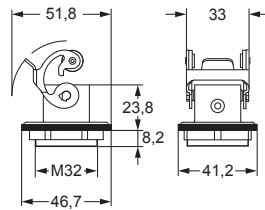

panel cut-out for MKAX IFC

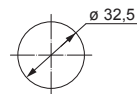

<sup>(\*)</sup> Locknut supplied with the enclosure



Type 12  
Type 4/4X only  
with CKR 65 (D)



IP66/IP67/IP69 with CKR 65 (D) <sup>1)</sup>



# MKA IFC - MKAXX IFC standard metallic version with flange gasket

<b>inserts</b>		<b>page:</b>
CK	3 and 4 poles + ⊕	58
CKS	3 and 4 poles + ⊕	-
CKSH	3 and 4 poles + ⊕	63
CD	8 poles	67
CQ4	2 poles + ⊕	182
CQ4 H	2 poles + ⊕	183
CQ4	3 poles + ⊕	184
CQ	5 poles + ⊕	186
CQ	7 poles + ⊕	187
CQ	12 poles + ⊕	189
CQ	21 poles	190
CJ KF		223
CJK 8FT		226
CJK 8IFT		228
CLK 04 SC		239
CX 1/2 BD		243
CXL 2/4 SF/SM		250
CXL SF/SM		250
CXL 2/4 PF/PM		251
CXL 2/4 PFH/PMH		251
CXL PF/PM		251

refer to CN.19 pages

## bulkhead mounting housings with flange gasket



GALVANIZED STEEL RIGID LEVER

## bulkhead mounting housings with flange gasket



STAINLESS STEEL RIGID LEVER

description	part No. (entry M32)	part No. (entry M32)
M32 fixing thread <sup>1)</sup>	<b>MKA IFC</b>	
M32 fixing thread <sup>1)</sup>		<b>MKAXX IFC</b>
gasket and screw kit for IP66/IP67/IP69 <sup>1)</sup>	<b>CKR 65</b>	<b>CKR 65</b>
gasket and screw kit for IP66/IP67/IP69 <sup>1)</sup> specific for CD 08 inserts	<b>CKR 65 D</b>	<b>CKR 65 D</b>

<sup>1)</sup> To obtain the IP66/IP67/IP69 degree of protection it is necessary to replace the fixing screw supplied with all inserts, with the one with gasket included in the kit (to be purchased separately) **except for** the inserts listed below (already supplied with a fixing screw with gasket):

- CQF/M 07, CQF/M 12
- CJ KF
- CJK 8FT /8IFT
- CX 1/2 BDF/M
- CLK 04 SCF /SCF-H /SCM
- CXL 2/4 PF /PM /PFH /PMH /SF /SM, CXL SF/M
- CXL PF /PM

NOTE: The enclosure shown here is an example. The screw and sealing gasket kit can be used with all enclosures' part nos. in this page

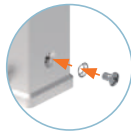

### MKA IFC

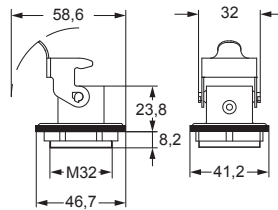

panel cut-out for MKA IFC

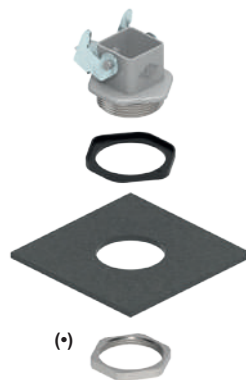
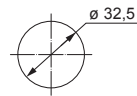

<sup>(\*)</sup> Locknut supplied with the enclosure

### MKAXX IFC

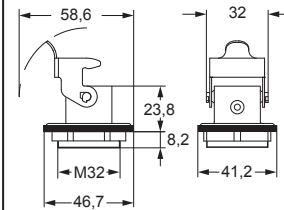

panel cut-out for MKAXX IFC

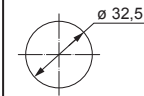

<sup>(\*)</sup> Locknut supplied with the enclosure

**CRUS**® Type 12  
Type 4/4X only  
with CKR 65 (D) <sup>(\*)</sup>

IP66/IP67/IP69 with CKR 65 (D) <sup>1)</sup>

---

IP68 ANGLED HOUSING FOR 2 INSERTS “21.21”  
MGK 2AP25

---

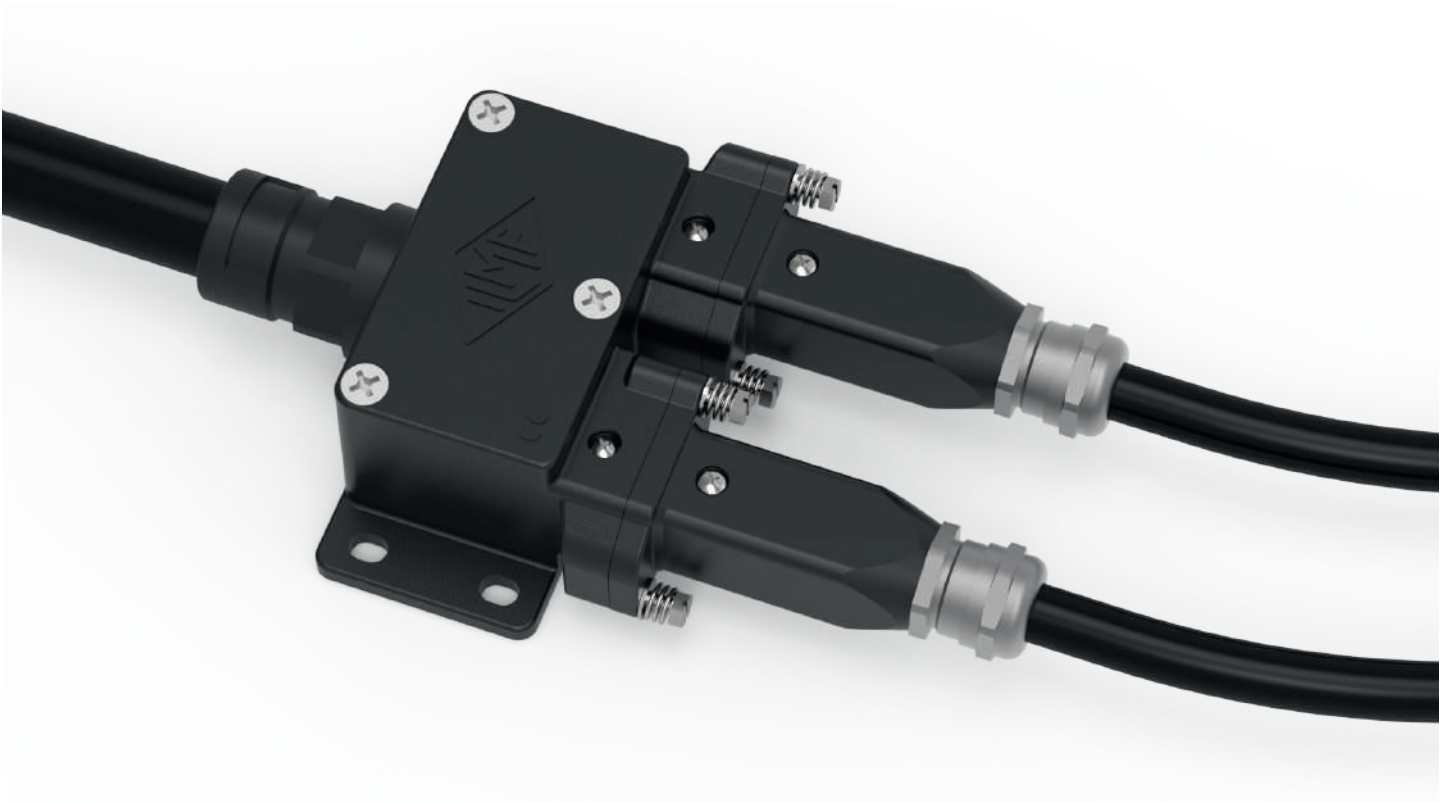

New special  
IP68 angled surface-mount  
enclosure



Find more  
information on  
our products at  
[www.ilme.com](http://www.ilme.com)

## TECHNICAL FEATURES

### MGK 2AP25



Watch  
our technical  
clip

The **CGK-MGK** series of size “21.21” connector enclosures with **IP68** degree of protection (as well as IPX6 and IPX9, hence IP66/IP68/IP69) is enriched by this new special angled surface-mount enclosure, consisting of a flanged box with screw cover incorporating on one side the interface of two size “21.21” bulkhead-mounting IP68 housings (mateable to two “21.21” CGK-MGK hoods) so as to host 2 connector inserts size “21.21” and on the opposite side an **M25** thread for an equally rated cable gland or conduit fitting.

**IP66/IP68/IP69** degree of protection per IEC 60529.

**Vibration and shock proof** per EN/IEC 61373 (railway rolling stock) **category 2** (bogie mounted).

**Corrosion proof** surface treatment and exposed parts up to **500 h** neutral salt spray chamber test according ISO 9227.

Suitable to build up a connectorized split/derivation (one line in, two connectors out).

Suitable for wall mounting with M6 head Ø 12,5 mm max. screws (length depending on the specific application) not supplied (see instruction sheet at page 98).

Couples with corresponding connector inserts inside **CGK-MGK** hoods.

**RoHS:** compliant without exemptions.

suitable to build up a  
connectorized split/  
derivation (one line in,  
two connectors out)



# MGK 2AP25 for 2 inserts high protection IP68 version

inserts		page:
<b>CK</b>	3 and 4 poles + ⊕	58
<b>CKS</b>	3 and 4 poles + ⊕	-
<b>CKSH</b>	3 and 4 poles + ⊕	63
<b>CD 1)</b>	8 poles	67
<b>CQ4</b>	2 poles + ⊕	182
<b>CQ4 H</b>	2 poles + ⊕	183
<b>CQ4</b>	3 poles + ⊕	184
<b>CQ</b>	5 poles + ⊕	186
<b>CQ</b>	7 poles + ⊕	187
<b>CQ</b>	12 poles + ⊕	189
<b>CQ</b>	21 poles	190
<b>CJ KF (can be used only in I enclosures)</b>		223
<b>CJK 8FT</b>		226
<b>CJK 8IFT</b>		226, 228
<b>CUK 2FT</b>		236
<b>CUK 3FT</b>		236
<b>CLK 04 SC</b>		239
<b>CX 1/2 BD</b>		243

refer to CN.19 pages

## angled bulkhead mounting housings for 2 inserts



description	part No.	entry M
with cable entry, bottom closed 2)	<b>MGK 2AP25</b>	25
internal PE terminal connection kit 3)	<b>CR MBT</b>	

1) To ensure IP68 degree of protection with **CD 08** insert, purchase the kit **CKR 65 D**.

☑ In this case do not use the gasket and screw kit supplied with the enclosure.

2) **CDF /M 07** series inserts (with pass-through protective earth contact) are suitable only by separate earthing of the housing through its internal PE terminal (**CR MBT kit** separately available), see note 3) below.

3) to be employed:

- for equipotential bonding connection between cover and housing PE terminals (2× required, see Instruction Sheet **page 99**);
- for PE connection of the housing (1× required) when used with CDF/M 07 inserts, see note 2) above

**CR MBT kit consists of:**

- Ø 4 mm eyelet crimp cable lug for 6 mm<sup>2</sup> max. PE wire, tin-plated brass;
- M3,5x6 self-tapping screw w/ Ph 2 head, stainless steel with Ø 4 mm washer.



### MGK 2AP25

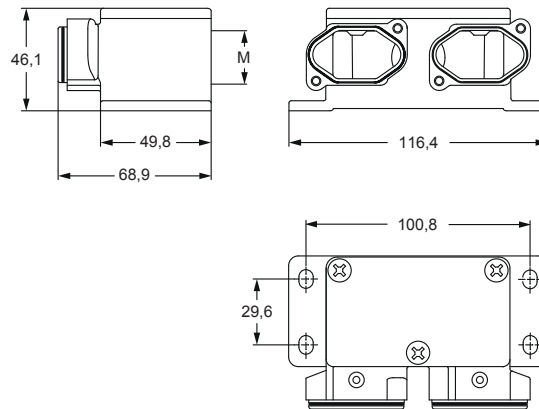

### panel cut-out for MGK 2AP25

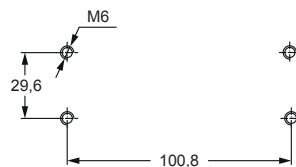

**CGKCP FX**  
dust protection cover  
(page 697 CN19 catalogue)



cURus  
Type 4/4X/12 pending



according to IEC/EN 60529

**MGK 2AP25 - ANGLED BULKHEAD MOUNTING HOUSINGS FOR 2 INSERTS "21.21"**



# MGK 2AP25 for 2 inserts high protection IP68 version

## ASSEMBLY INSTRUCTIONS

### MGK 2AP25 FOR 2 INSERTS

1

Remove the gasket from the male insert before use

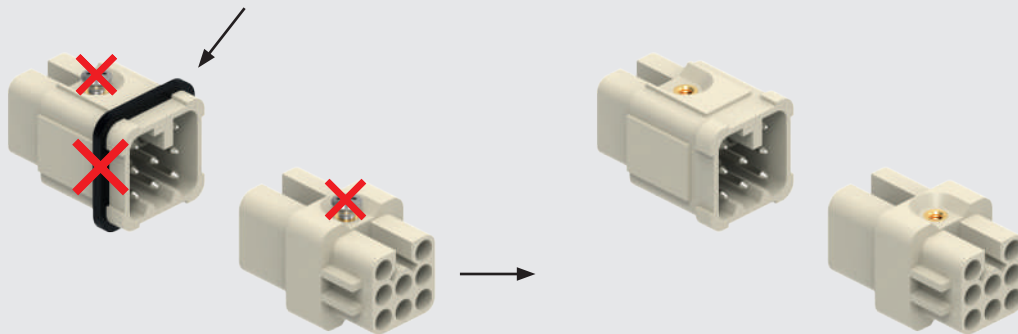

Inserts may differ from those depicted

2

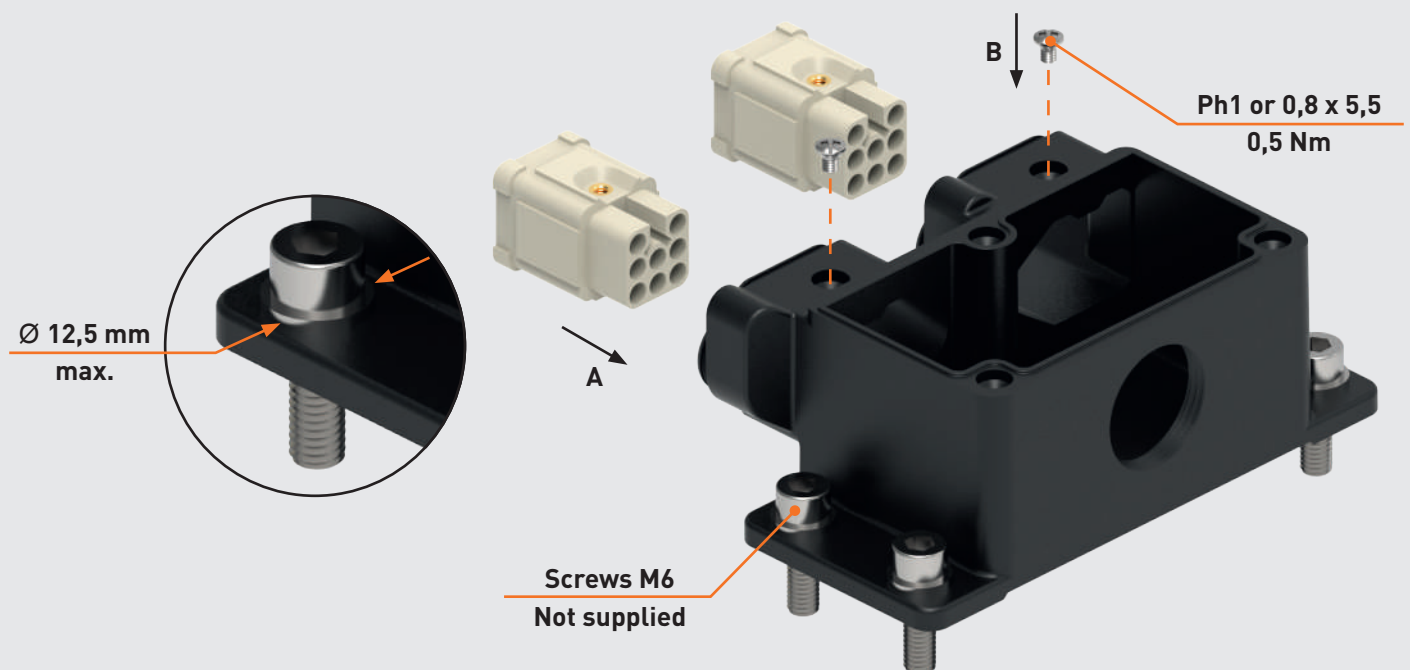

**ASSEMBLY INSTRUCTIONS**  
**MGK 2AP25 FOR 2 INSERTS**

3

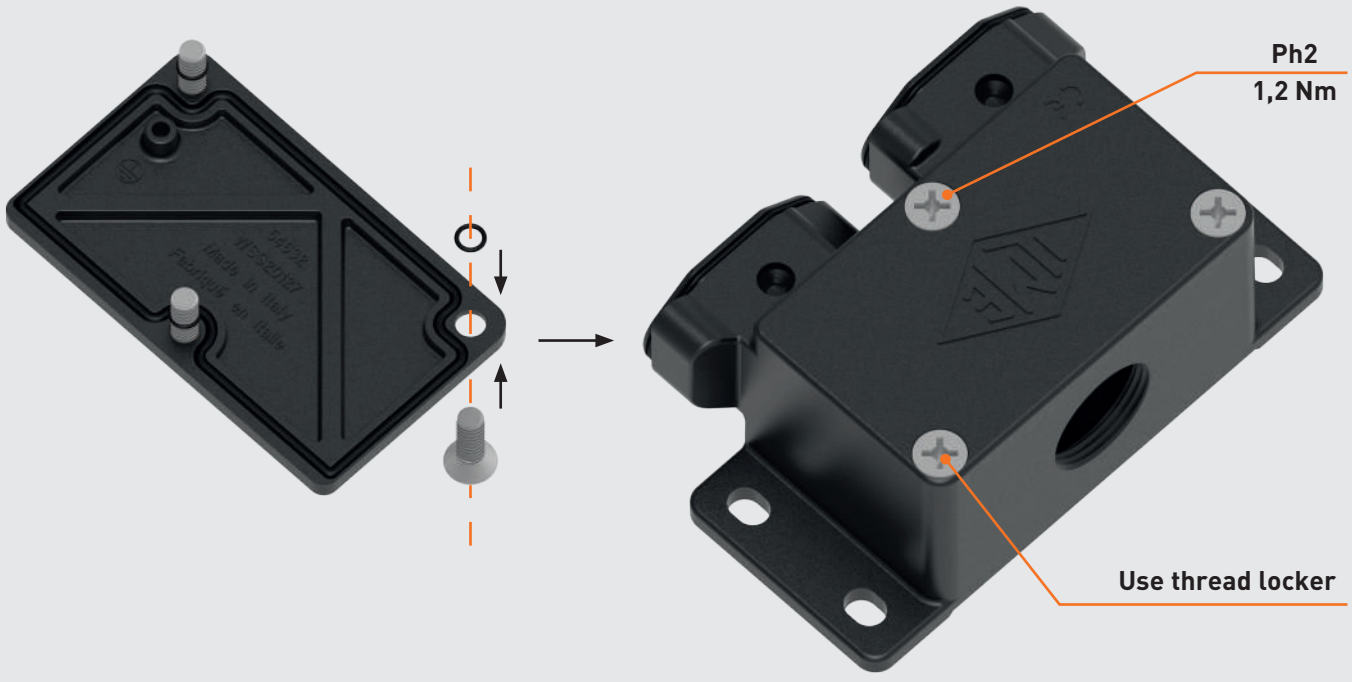

SEPARATELY  
AVAILABLE

CR MBT

1X

6 mm<sup>2</sup> max.

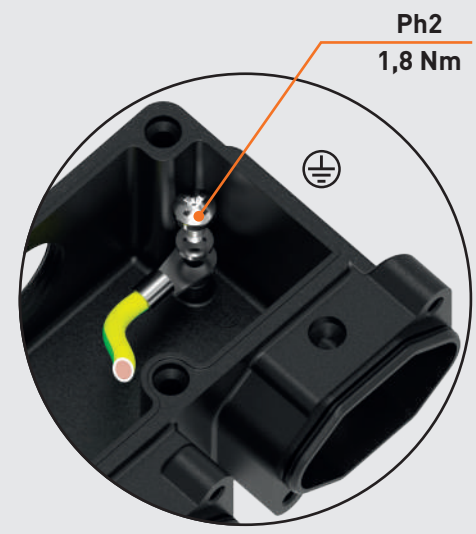
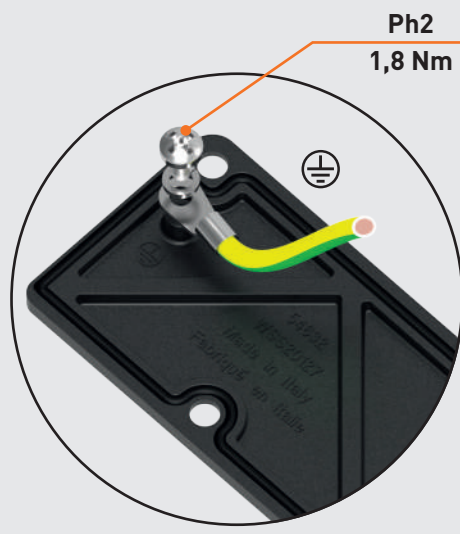



---

## T-TYPE HYGIENIC WITH METAL-DETECTABLE LEVERS

---



Locking lever(s)  
made of metal detectable  
thermoplastic material,  
suitable for food contact



Find more  
information on  
our products at  
[www.ilme.com](http://www.ilme.com)



# TECHNICAL FEATURES

## T-TYPE/H & T-TYPE/C



Watch  
our technical  
clip

Series **T-TYPE HYGIENIC** enclosures with locking lever (both the /H and the /C versions), likewise the recently introduced **CKH-MKH HYGIENIC** size "21.21" series of enclosures (see ILME NEWS 2020 catalogue, pages 106-115), are now updated with the locking lever(s) made of **metal detectable thermoplastic material**, suitable for food contact.

Metal detection of foreign objects in food processing plants is widely used as a means to guarantee from accidental loss of such parts in food prior to its further processing, canning, bottling or packaging in general.

In addition to the blue colour, that helps to optically detect through surveillance cameras the presence of parts clearly alien to food (no blue natural food is known, hence the choice of this colour), metal detection comes in help, as already popular in food processing.

**Part Numbers remain unchanged.**  
Zip code **will be announced by a dedicated Product Info.**

**FROM JUNE 2021**

Size	Cable outlet	Locking lever	T-TYPE HYGIENIC /H		T-TYPE HYGIENIC Cold /C	
			part No.	part No.*	part No.	part No.*
44.27	-	single	THIH 06 L	THIH 06 LB	THIC 06 L	THIC 06 LB
57.27	-	double	THIH 10	THIH 10 B	THIC 10	THIC 10 B
77.27	-		THIH 16	THIH 16 B	THIC 16	THIC 16 B
104.27	-		THIH 24	THIH 24 B	THIC 24	THIC 24 B
44.27	M25	single	TAPH 06 L25	TAPH 06L25B	TAPC 06 L25	TAPC 06L25B
	M32		TAPH 06 L32	TAPH 06L32B	TAPC 06 L32	TAPC 06L32B
	2xM25		TAPH 06 L225	TAPH06L225B	TAPC 06 L225	TAPC06L225B
	2xM32		TAPH 06 L232	TAPH06L232B	TAPC 06 L232	TAPC06L232B
57.27	M25	double	TAPH 10.25	TAPH 10.25B	TAPC 10.25	TAPC 10.25B
	M32		TAPH 10.32	TAPH 10.32B	TAPC 10.32	TAPC 10.32B
	2xM25		TAPH 10.225	TAPH10.225B	TAPC 10.225	TAPC10.225B
	2xM32		TAPH 10.232	TAPH10.232B	TAPC 10.232	TAPC10.232B
77.27	M32	double	TAPH 16.32	TAPH 16.32B	TAPC 16.32	TAPC 16.32B
	M40		TAPH 16.40	TAPH 16.40B	TAPC 16.40	TAPC 16.40B
	2xM32		TAPH 16.232	TAPH16.232B	TAPC 16.232	TAPC16.232B
	2xM40		TAPH 16.240	TAPH16.240B	TAPC 16.240	TAPC16.240B
104.27	M32	double	TAPH 24.32	TAPH 24.32B	TAPC 24.32	TAPC 24.32B
	M40		TAPH 24.40	TAPH 24.40B	TAPC 24.40	TAPC 24.40B
	2xM32		TAPH 24.232	TAPH24.232B	TAPC 24.232	TAPC24.232B
	2xM40		TAPH 24.240	TAPH24.240B	TAPC 24.240	TAPC24.240B
44.27	M25	single	TAVH 06 LG25	TAVH06LG25B	TAVC 06 LG25	TAVC06LG25B
	M32		TAVH 06 LG32	TAVH06LG32B	TAVC 06 LG32	TAVC06LG32B
57.27	M25	double	TAVH 10 G25	TAVH 10G25B	TAVC 10 G25	TAVC 10G25B
	M32		TAVH 10 G32	TAVH 10G32B	TAVC 10 G32	TAVC 10G32B
77.27	M32		TAVH 16 G32	TAVH 16G32B	TAVC 16 G32	TAVC 16G32B
	M40		TAVH 16 G40	TAVH 16G40B	TAVC 16 G40	TAVC 16G40B
104.27	M32	double	TAVH 24 G32	TAVH 24G32B	TAVC 24 G32	TAVC 24G32B
	M40		TAVH 24 G40	TAVH 24G40B	TAVC 24 G40	TAVC 24G40B

\* Enclosures with protective earth jumpers CR...BPE preassembled with part No. of base model plus **letter B** at the end.

Size	With loop	Locking lever	Covers for T-TYPE HYGIENIC	Covers for T-TYPE HYGIENIC Cold
			part No.	part No.
44.27		single	THCH 06 LG	THCC 06 LG
57.27		double	THCH 10 G	THCC 10 G
77.27			THCH 16 G	THCC 16 G
104.27			THCH 24 G	THCC 24 G

---

PLANARITY GASKETS  
FOR T-TYPE SURFACE MOUNTING HOUSING  
CR 06 /10 /16 /24 GTPC

---



Suitable for of all sizes  
of the T-TYPE HYGIENIC /H and /C



Find more  
information on  
our products at  
[www.ilme.com](http://www.ilme.com)

## TECHNICAL FEATURES

### CR 06 /10 /16 /24 GTPC



Watch  
our technical  
clip

Available in four dedicated sizes.

Suitable for closing the gap underneath wall-mounting housings of all sizes “44.27”, “57.27”, “77.27” and “104.27” of the **T-TYPE HYGIENIC** (both **/H** and **/C** for cold applications).

Re-establish planarity of the bottom (base) of these housings, thus avoiding the potential “nesting” of hazardous dirt in a gap otherwise difficult to be fully cleaned with washing in HYGIENIC applications.

Made with food grade silicone, blue coloured.

it closes the gap  
underneath  
wall-mounting  
housings of all  
sizes of the T-TYPE  
HYGIENIC

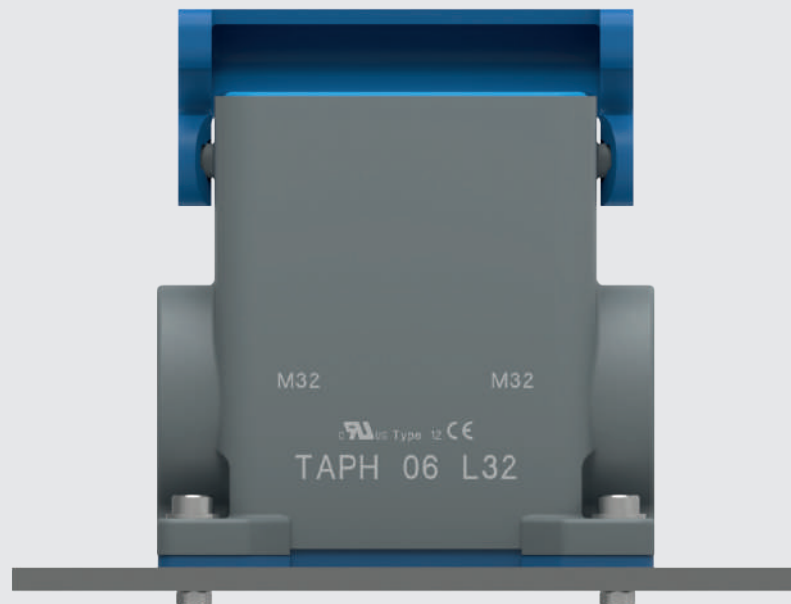

# CR 06/10/16/24 GTPC planarity gaskets for T-TYPE surface mounting housing

T-TYPE surface mounting housing:

page:

T-TYPE / H	
size "44.27"	501
size "57.27"	502
size "77.27"	503
size "104.27"	504
T-TYPE / C	
size "44.27"	506
size "57.27"	507
size "77.27"	508
size "104.27"	509

planarity gasket for T-TYPE surface mounting housing

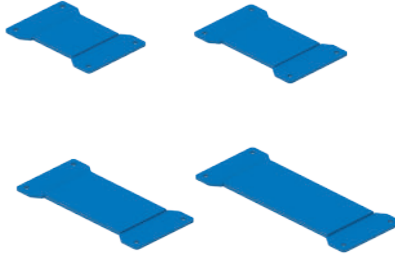

refer to CN.19 pages

description	part No.
-------------	----------

planarity gasket for surface mount T-TYPE size "44.27"	<b>CR 06 GTPC</b>
planarity gasket for surface mount T-TYPE size "57.27"	<b>CR 10 GTPC</b>
planarity gasket for surface mount T-TYPE size "77.27"	<b>CR 16 GTPC</b>
planarity gasket for surface mount T-TYPE size "104.27"	<b>CR 24 GTPC</b>

- food grade silicone, blue colour

CR GTPC

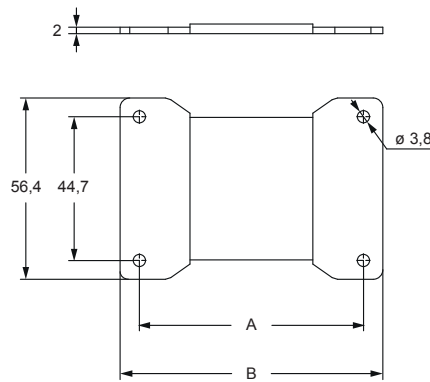

part No.	polarity	A	B
<b>CR 06 GTPC</b>	06	69,7	81,7
<b>CR 10 GTPC</b>	10	81,7	93,9
<b>CR 16 GTPC</b>	16	104,7	116,7
<b>CR 24 GTPC</b>	24	131,7	143,6

## ASSEMBLY INSTRUCTIONS

## CR GTPC

- \* Screws, washers and counternuts not provided (installation dependent)

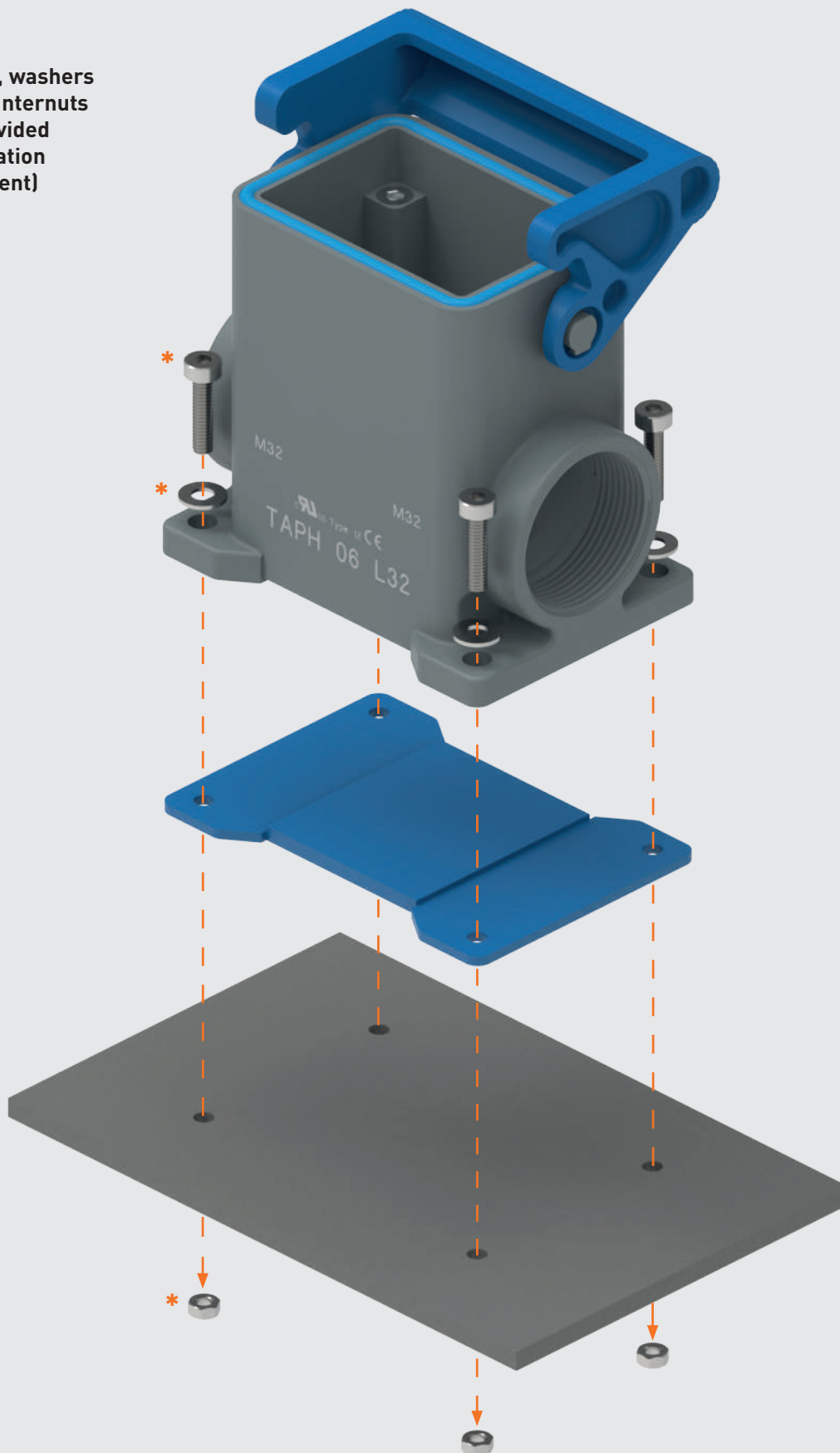

---

## FLANGE GASKET FOR MKAS IVG20 CR 03 GKIVGR

---



The new replacement rubber flange sealing gasket allows a 180° reversed installation of the MKAS /MKAXS /MKAXXS IVG20 special EMC housings



Find more information on our products at [www.ilme.com](http://www.ilme.com)

## TECHNICAL FEATURES

### CR 03 GKIVGR



Watch  
our technical  
clip

The new **CR 03 GKIVGR** replacement rubber flange sealing gasket allows a 180° reversed installation of the special housings **MKAS IVG20**, so as to get the mating connector and the locking lever inside the cabinet and the M20 cable outlet outside the cabinet. This **allows installation of preassembled connector wirings on a cabinet wall**.

The **MKAS IVG20** special zinc alloy hoods with M20 rear cable entry with additional flange for the bulkhead mounting to a cabinet wall, for all connector inserts size "21.21" (available with different levers as MKAS, MKAXS or MKAXXS) are foreseen for being installed on the outside wall of a cabinet.

In the standard installation the cable outlet results inside the cabinet and the locking lever to mate and lock with the corresponding connector is outside the cabinet.

To allow reverse mounting, the new **CR 03 GKIVGR** flange gasket must be fitted on the bare flange face, the captive gasket needs to be removed, then the **MKAS IVG20** housing is passed through a panel cut-out of suitably enlarged base, so as to let the locking lever and pegs pass-through the wall. Screws can then be fitted and tightened by suitable counternuts.

IP44, IP66/IP67/IP69 with CKR 65(D)

NOTE - The sealing on the 4 pass-through fixing screw must be duly restored by the customer

cURus pending [Type 12 / Type 4, 4X only with CKR 65(D)]

**RoHS:** compliant without exemptions.

the installation  
of preassembled  
connector wirings  
on a cabinet wall  
is allowed

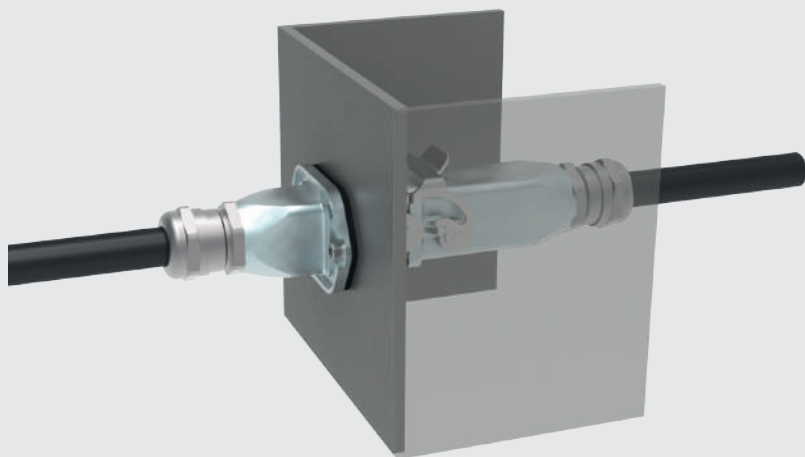

## CR 03 GKIVGR flange gasket for MKAS IVG20 reverse mounting

enclosures  
size "21.21"

page:

flange gasket  
for MKAS IVG20 reverse mounting

MKAS IVG20 (bulkhead mounting housings) 571



refer to CN.19 pages

description

part No.

flange gasket for reverse installation

CR 03 GKIVGR

☑ The new **CR 03 GKIVGR** replacement rubber flange sealing gasket allows a 180° reversed installation of the special housings **MKAS IVG20**, so as to get the mating connector and the locking lever inside the cabinet and the M20 cable outlet outside the cabinet. This allows installation of preassembled connector wirings on a cabinet wall.

CR 03 GKIVGR

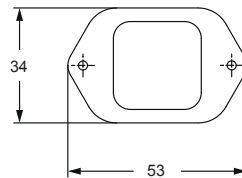
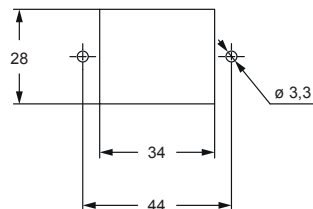
panel cut-out for reverse mounting  
with CR 03 GKIVGR



**ASSEMBLY INSTRUCTIONS**  
**CR 03 GKIVGR ON MKAS IVG20**

1

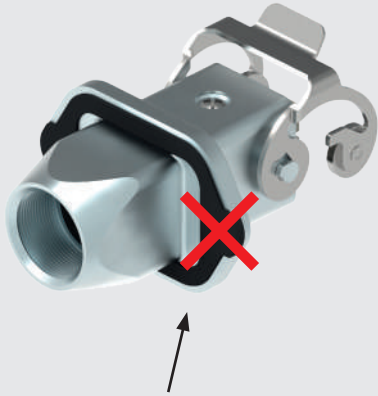

Remove the captive gasket  
supplied with the MKAS IVG20  
housing

2

Fit the new flange gasket  
on the opposite side

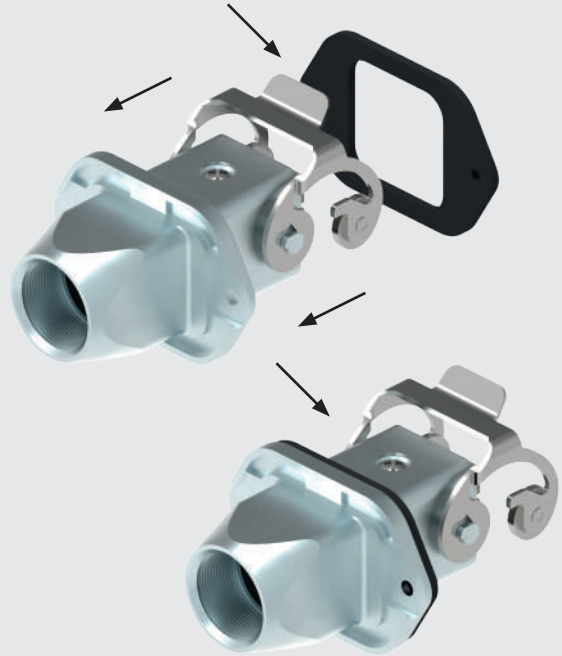

3

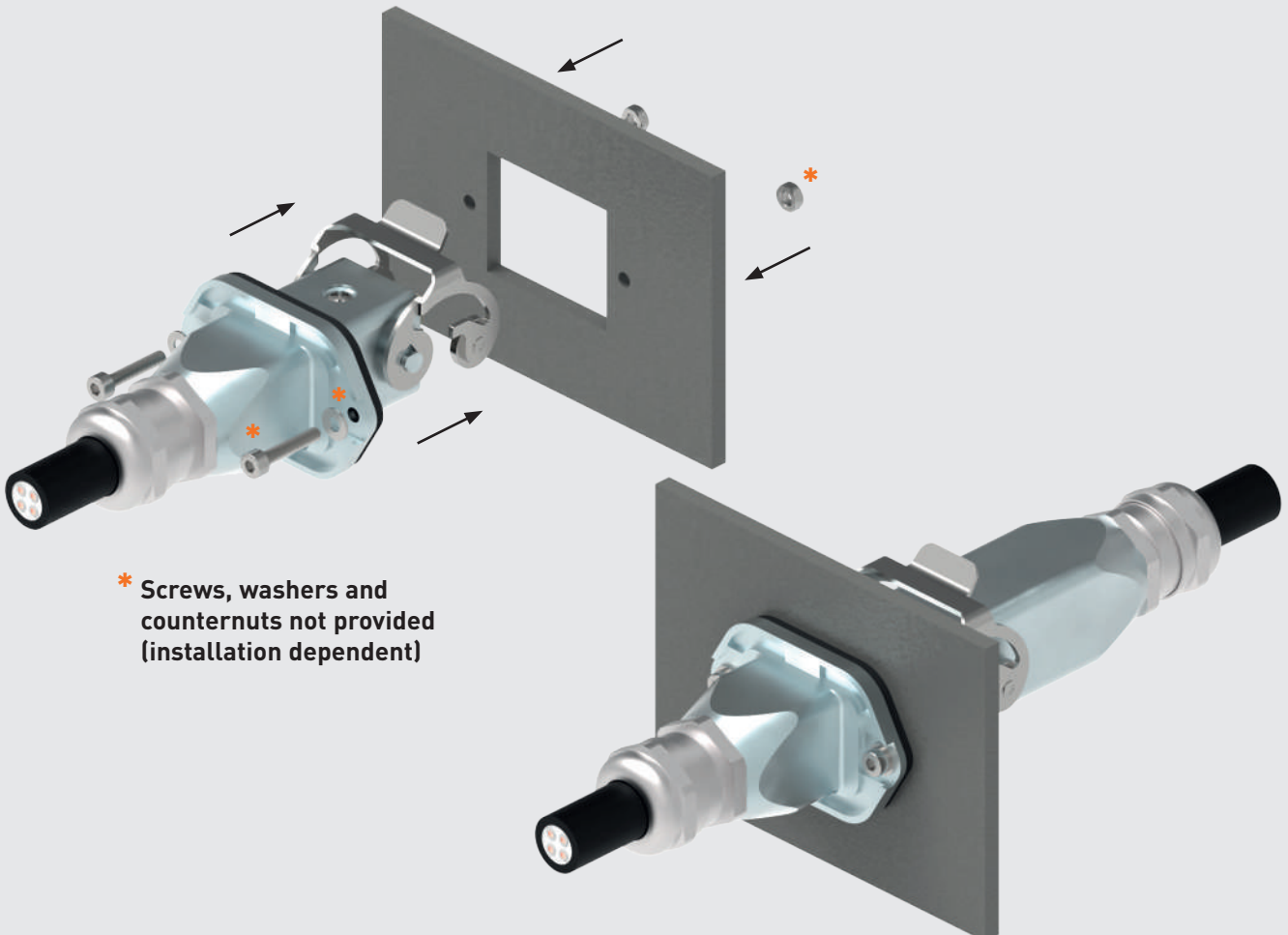

\* Screws, washers and  
counternuts not provided  
(installation dependent)

---

**COVER SIZE "104.62" WITH LEVER AND GASKET  
CHC 48 LG**

---

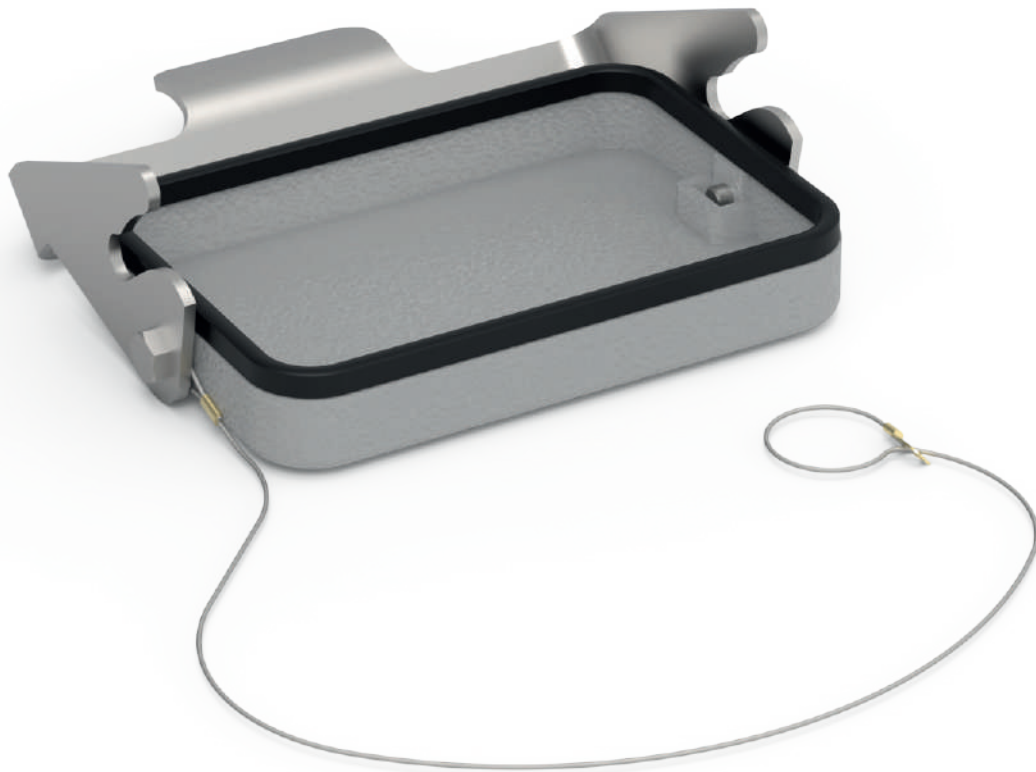

**Metal cover size "104.62"  
with stainless steel locking lever  
and gasket**



Find more  
information on  
our products at  
[www.ilme.com](http://www.ilme.com)

## TECHNICAL FEATURES

### CHC 48 LG

Equipped with stainless-steel locking lever and edge sealing gasket, this cover is suitable to close a "104.62" connector hood with 2 pegs (see CN.19 p. 430), to provide:

- **IP65** degree of protection if the cable gland or fitting is insulating type without gasket, or
- **IP66/IP69** if the cable gland/conduit fitting is equipped with O-ring,

in installations where the free connector would otherwise be expected to remain for prolonged time unmated, thus open and unduly exposed to environmental conditions affecting the contacts and relevant terminations.

Cover attachable to the free cable assembly terminating with a "104.62" connector hood by means of the dedicated stainless-steel loop cord.

**RoHS:** compliant without exemptions.

metal cover  
size "104.62"  
attachable to the  
free cable assembly  
by means of the  
dedicated stainless  
steel loop cord



# CHC 48 LG cover for size "104.62" C-TYPE standard version

inserts		page:
CD	128 poles + ⊕	74
CDD	216 poles + ⊕	83
CDS	84 poles + ⊕	-
CDSH	84 poles + ⊕	91
CNE	48 poles + ⊕	115
CSE	48 poles + ⊕	-
CSH	48 poles + ⊕	115
CSH S	48 poles + ⊕	127
CCE	48 poles + ⊕	135
CME	20+4 (aux) poles + ⊕	144
CMSH	20+4 (aux) poles + ⊕	144
CSS	48 poles + ⊕	153
CTSE (16A) *)	48 poles + ⊕	165
CQE	92 poles + ⊕	173
MIXO	6 + 6 modules	262 - 317

\*) can be used only in bulkhead mounting housings

insert dimensions: **2 x (104 x 27) mm**

refer to CN.19 pages

## cover



## description

part No.  
(with loop)

with 1 lever and gasket (for hoods with 2 pegs)

**CHC 48 LG**

- aluminium alloy die cast, epoxy polyester powder coated, grey RAL 7040
- stainless steel rigid locking lever and bolts
- stainless steel loop cord

**CHC 48 LG**

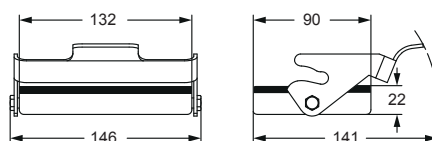

## For fixing on hoods

loop

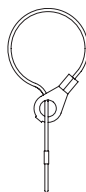

cURus  
Type 4/4X/12 pending



insulating cable gland or fittings  
without gasket



cable gland  
with O-Ring gasket

**CHC 48 LG - COVER "104.62" WITH LEVER AND GASKET**



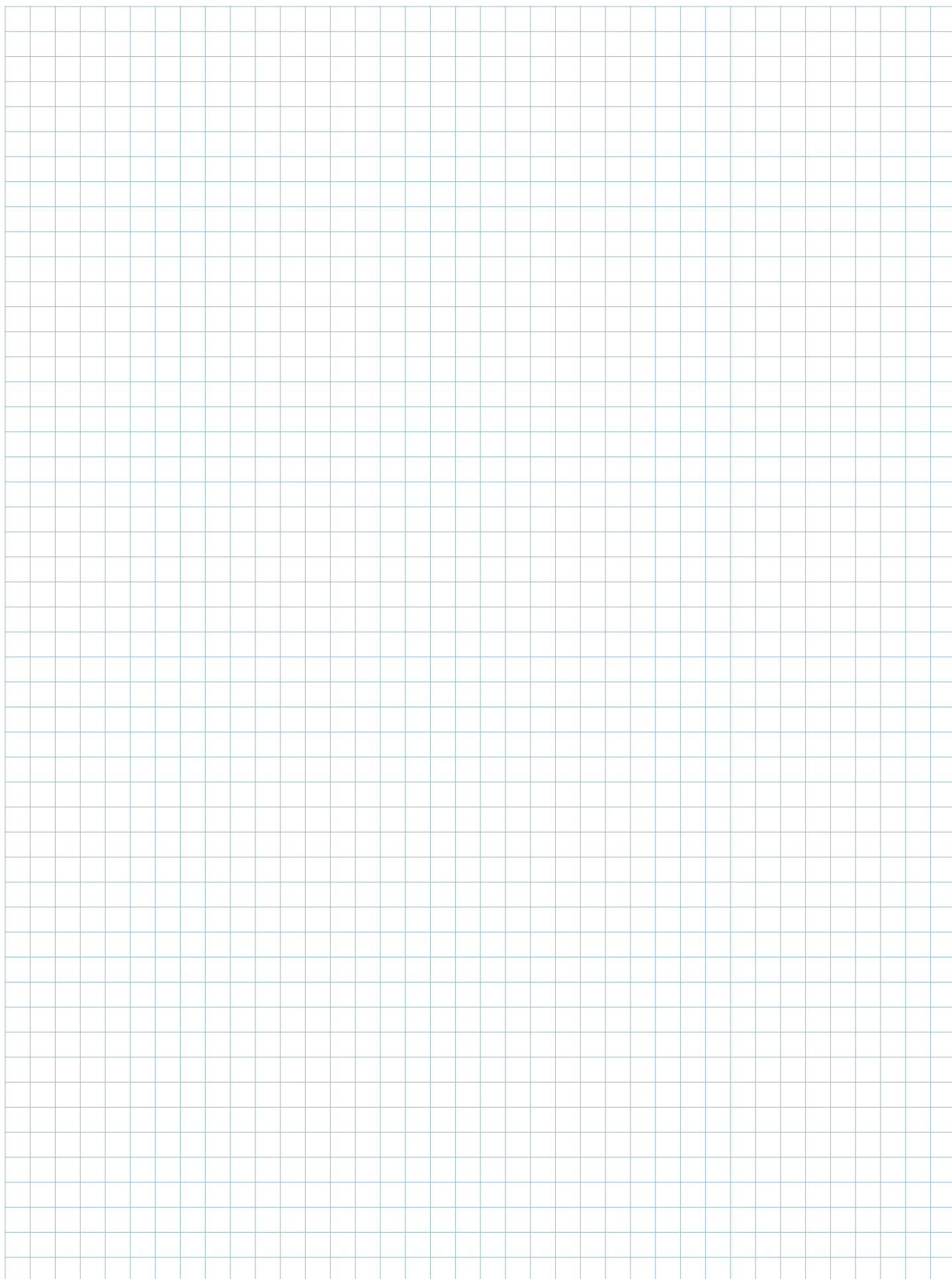

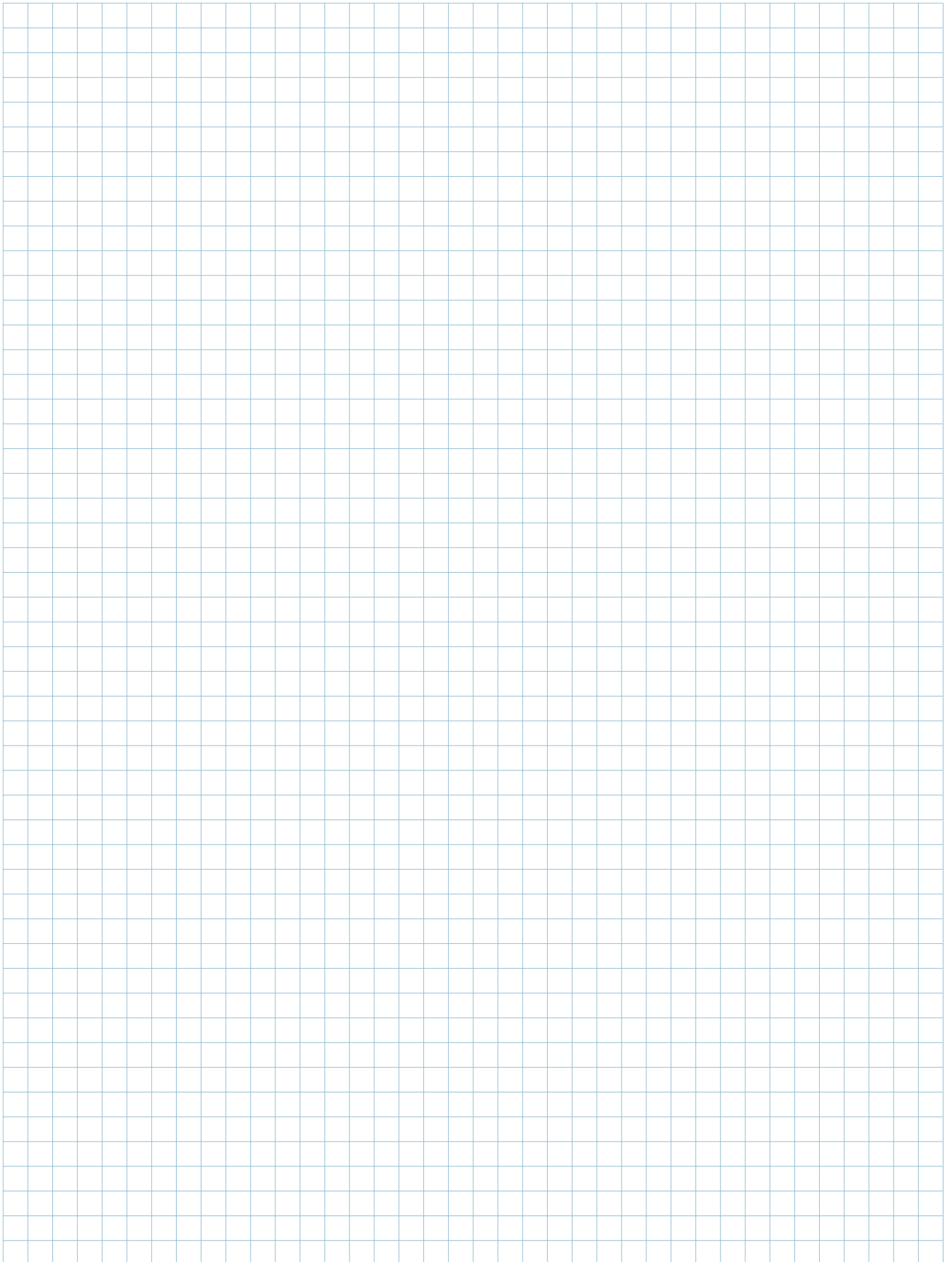

**C**

CCFA 0.3.....	17, 21
CCFA 0.5.....	17, 21
CCFA 0.7.....	17, 21
CCFA 1.0.....	17, 21
CCFA 1.5.....	17, 21
CCFA 2.5.....	17, 21
CCFA 3.0.....	17, 21
CCFA 4.0.....	17, 21
CCMA 0.3.....	17, 21
CCMA 0.5.....	17, 21
CCMA 0.7.....	17, 21
CCMA 1.0.....	17, 21
CCMA 1.5.....	17, 21
CCMA 2.5.....	17, 21
CCMA 3.0.....	17, 21
CCMA 4.0.....	17, 21
CDFA 6A.....	84
CDFD 0.3.....	53
CDFD 0.5.....	53
CDFD 0.7.....	53
CDFD 1.0.....	53
CDFD 1.5.....	53
CDFD 2.5.....	53
CDMA 6A32.....	84
CDMD 0.3.....	53
CDMD 0.5.....	53
CDMD 0.7.....	53
CDMD 1.0.....	53
CDMD 1.5.....	53
CDMD 2.5.....	53
CGFA 10.....	26
CGFA 16.....	26
CGFA 25.....	26
CGFA 35.....	26
CGMA 10.....	26
CGMA 16.....	26
CGMA 25.....	26
CGMA 35.....	26
CHC 48 LG.....	112
CIF 5 2.4.....	84
CIFD 0.2.....	61, 67
CIFD 0.3.....	61, 67
CIFD 0.5.....	61, 67
CIF X17 2.4.....	84
CIMD 0.2.....	61, 67
CIMD 0.3.....	61, 67
CIMD 0.5.....	61, 67
CJZA 8 IA4.....	88
CJZAX 8 IA4.....	88
CJZAXX 8 IA4.....	89
CKR 65.....	92, 93
CKR 65 D.....	92, 93
CQES.....	17, 21
CR 03 GKIVGR.....	108
CR 06 GTPC.....	104
CR 10 GTPC.....	104
CR 16 GTPC.....	104
CR 24 GTPC.....	104
CR CDS.....	36*
CR MBT.....	96
CX 01 J8UM.....	48
CX 02 TF.....	76
CX 02 TM.....	76
CX 3.0 MPAF.....	75
CX 3.0 MPAM.....	75
CX 3.0 MPAV.....	75
CX 3.0 MPF.....	74
CX 3.0 MPM.....	74
CX 3.0 MPQF.....	75
CX 3.0 MPQM.....	75
CX 3.0 MPQV.....	75
CX 3.0 MPV.....	74
CX 03 MP.....	74
CX 03 TF.....	76
CX 03 TM.....	76
CX 4.0 MPAF.....	75
CX 4.0 MPAM.....	75
CX 4.0 MPAV.....	75
CX 4.0 MPF.....	74
CX 4.0 MPM.....	74
CX 4.0 MPQF.....	75
CX 4.0 MPQM.....	75
CX 4.0 MPQV.....	75
CX 4.0 MPV.....	74
CX 04 TF.....	76
CX 04 TM.....	76
CX 5/7 CA.....	53*
CX 6.0 MPAF.....	75
CX 6.0 MPAM.....	75
CX 6.0 MPAV.....	75
CX 6.0 MPF.....	74
CX 6.0 MPM.....	74
CX 6.0 MPQF.....	75
CX 6.0 MPQM.....	75
CX 6.0 MPQV.....	75
CX 6.0 MPV.....	74
CX 06 TF.....	76
CX 06 TM.....	76
CX 7/10 CA.....	53*
CX7ES.....	17, 21
CX7FA 6.0.....	16, 20
CX7FA 10.....	16, 20
CX7FA 16.....	16, 20
CX7FA 25.....	16, 20
CX7MA 6.0.....	16, 20
CX7MA 6.0 P.....	80
CX7MA 10.....	16, 20
CX7MA 10 P.....	80
CX7MA 16.....	16, 20
CX7MA 16 P.....	80
CX7MA 25.....	16, 20
CX7MA 25 P.....	80
CX 08 D5GF.....	52
CX 08 D5GF2.....	52
CX 08 D5GM.....	52
CX 08 D5GM2.....	52
CX 08 I6GF.....	60
CX 08 I6GM.....	60
CX 10/12 CA.....	53*
CX 11/14 CA.....	60*
CX 20S IGF.....	66
CX 20S IGM.....	66
CXCF 4/2.....	16
CXCF 4/8.....	20
CXCM 4/2.....	16
CXCM 4/8.....	20
CXF 8/0.....	26
CXM 8/0.....	26

**M**

MGK 2AP25.....	96
MKA IFC.....	93
MKAX IFC.....	92
MKAXX IFC.....	93

\* These items are also shown in various sections throughout the catalogue



## R

RDF2D 0.3.....	55	RX 08 D5GM.....	54
RDF2D 0.5.....	55	RX 08 D5GM2.....	54
RDF2D 0.7.....	55	RX 08 I6GF.....	62
RDF2D 1.0.....	55	RX 08 I6GM.....	62
RDF2D 1.5.....	55	RX 20S IGF.....	68
RDF2D 2.5.....	55	RX 20S IGM.....	68
RDM2D 0.3.....	55		
RDM2D 0.5.....	55		
RDM2D 0.7.....	55		
RDM2D 1.0.....	55		
RDM2D 1.5.....	55		
RDM2D 2.5.....	55		
RDSHF 09.....	36		
RDSHF 18.....	37		
RDSHF 27.....	38		
RDSHF 42.....	39		
RDSHM 09.....	36		
RDSHM 18.....	37		
RDSHM 27.....	38		
RDSHM 42.....	39		
RIFD 0.2.....	63, 69		
RIFD 0.3.....	63, 69		
RIFD 0.5.....	63, 69		
RIMD 0.2.....	63, 69		
RIMD 0.3.....	63, 69		
RIMD 0.5.....	63, 69		
RSHF 06.....	30		
RSHF 10.....	31		
RSHF 16.....	32		
RSHF 24.....	33		
RSHM 06.....	30		
RSHM 10.....	31		
RSHM 16.....	32		
RSHM 24.....	33		
RX 02 TF.....	77		
RX 02 TM.....	77		
RX 03 TF.....	77		
RX 03 TM.....	77		
RX 04 TF.....	77		
RX 04 TM.....	77		
RX 06 TF.....	77		
RX 06 TM.....	77		
RX 08 D5GF.....	54		
RX 08 D5GF2.....	54		

# Worldwide Sales Organization

## Headquarters

### ILME S.p.A.

Via M.A. Colonna, 9  
20149 Milano, Italia  
T +39 0234560522  
info@ilme.com

## France

### ILME FRANCE S.A.R.L.

431 rue Roland Garros  
Parc d'Activités de l'Aéroport  
42160 Andrézieux-Bouthéon  
T +33 04 7736 2336  
ilme-france@ilme.fr

## Sweden

### and Nordic Countries

### ILME NORDIC AB

Transportvägen 18  
246 42 Löddeköpinge  
T +46 4618 2800  
info@ilme.se

## Czech Republic Representative Office

### ILME S.p.A.

Business Center Rokytká  
Sokolovská 270/201  
Vysocany, Praha 9, 190 00  
info@ilme.cz

## Japan

### ILME JAPAN CO. LTD.

K.I.B.C. Bldg 5-2  
Minatojima Minamimachi 5-Chome  
Chuo-Ku, Kobe 650-0047  
T +81 78 302 2005  
info@ilmejapan.co.jp

## Germany

### ILME GmbH

Max-Planck-Straße 12  
51674 Wiehl  
T +49 (0)2261 7955 0  
technik@ilme.de

## United Kingdom

### ILME UK LIMITED

50 Evans Road, Venture Point  
Speke, Liverpool L24 9PB  
T +44 0151 336 9321  
sales@ilmeuk.co.uk

## China

### ILME CHINA CO. LTD.

Room 101, Building 3  
188 Xinjunhuan Road, Minhang  
Shanghai 201114  
T +86 21 6248 9961  
info@ilmechina.com

## South Korea

### ILME KOREA CO.

714, DaeRyung Technotown 20<sup>th</sup>  
5 Gasan Digital 1-Ro, GeumCheon-Gu  
Seoul 08594  
T +82-2-2225-8432  
sales@ilme.kr

[www.ilme.com](http://www.ilme.com)





**ILME S.p.A.**  
Via M.A. Colonna 9  
20149 Milano, Italy  
[www.ilme.com](http://www.ilme.com)

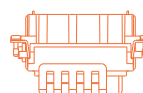
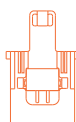
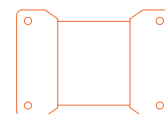
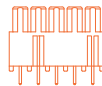
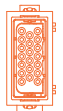
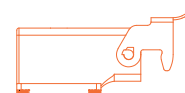
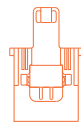
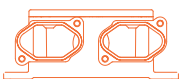
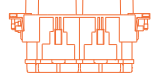
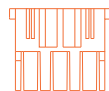
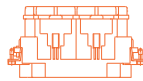
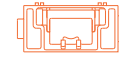
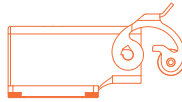
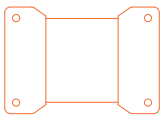
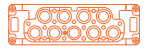
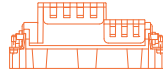
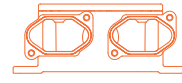
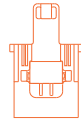
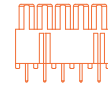
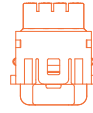

XDGPDT21 621



catalogues